



Rettungsdatenblätter

Modellbezeichnung

- C
- > Citigo 3-Türer
 - > Citigo 3-Türer CNG
 - > Citigo 5-Türer
 - > Citigo 5-Türer CNG
- F
- > Felicia
 - > Felicia Combi
 - > Fabia I
 - > Fabia Sedan I
 - > Fabia Combi I
 - > Fabia II
 - > Fabia Combi II
 - > Fabia III
- O
- > Octavia I
 - > Octavia Combi I
 - > Octavia II
 - > Octavia Combi II
 - > Octavia II LPG
 - > Octavia Combi II LPG
 - > Octavia III
 - > Octavia III CNG
 - > Octavia Combi III
 - > Octavia Combi III CNG
- P
- > Pick up
 - > Praktik
- R
- > Roomster
 - > Rapid
 - > Rapid Spaceback
- S
- > Superb I
 - > Superb II
 - > Superb Combi II
- Y
- > Yeti

Modellzyklus

- ab 2011
 - ab 2012
 - ab 2012
 - ab 2012
-
- 1994 - 2001
 - 1995 - 2001
 - 1999 - 2007
 - 2001 - 2008
 - 2000 - 2007
 - 2006 - 2014
 - 2006 - 2014
 - ab 2014
-
- 1996 - 2010
 - 2000 - 2010
 - 2004 - 2013
 - 2004 - 2013
 - 2009 - 2013
 - 2009 - 2013
 - ab 2012
 - ab 2014
 - ab 2013
 - ab 2014
-
- 1995 - 2001
 - ab 2006
-
- ab 2006
 - ab 2012
 - ab 2013
-
- 2001 - 2008
 - ab 2008
 - ab 2009
-
- ab 2009

**Hinweis:**

Diese Dokumentation wurde ausschließlich für Rettungskräfte erstellt, die über eine spezielle Ausbildung auf dem Gebiet der technischen Hilfeleistung nach Verkehrsunfällen und damit in Verbindung stehender Tätigkeiten verfügen.

Spezifikationen und Sonderausstattungen der Škoda-Fahrzeuge sowie das Fahrzeugangebot der **ŠKODA AUTO a.s.** unterliegen stetig etwaigen Änderungen. Daher behält sich Škoda Auto a.s. inhaltliche Anpassungen bzw. Änderungen jederzeit ausdrücklich vor.

Beachten Sie bitte, dass die in dieser Dokumentation enthaltenen Informationen nicht für Endkunden und ebenfalls nicht für Werkstätten und Händler bestimmt sind. Endkunden finden detaillierte Informationen zu den Funktionen ihres Fahrzeugs sowie wichtige Sicherheitshinweise zur Fahrzeug- und Insassensicherheit in den Bordbüchern jedes Škoda-Fahrzeugs. Werkstätten und Händler können die nötigen Reparaturinformationen über die ihnen bekannten Bezugsquellen erhalten.

(Stand: Oktober 2014)

Hinweis:

In den Modellübersichten ist immer die maximal mögliche Ausstattung eines Fahrzeugs gezeigt.





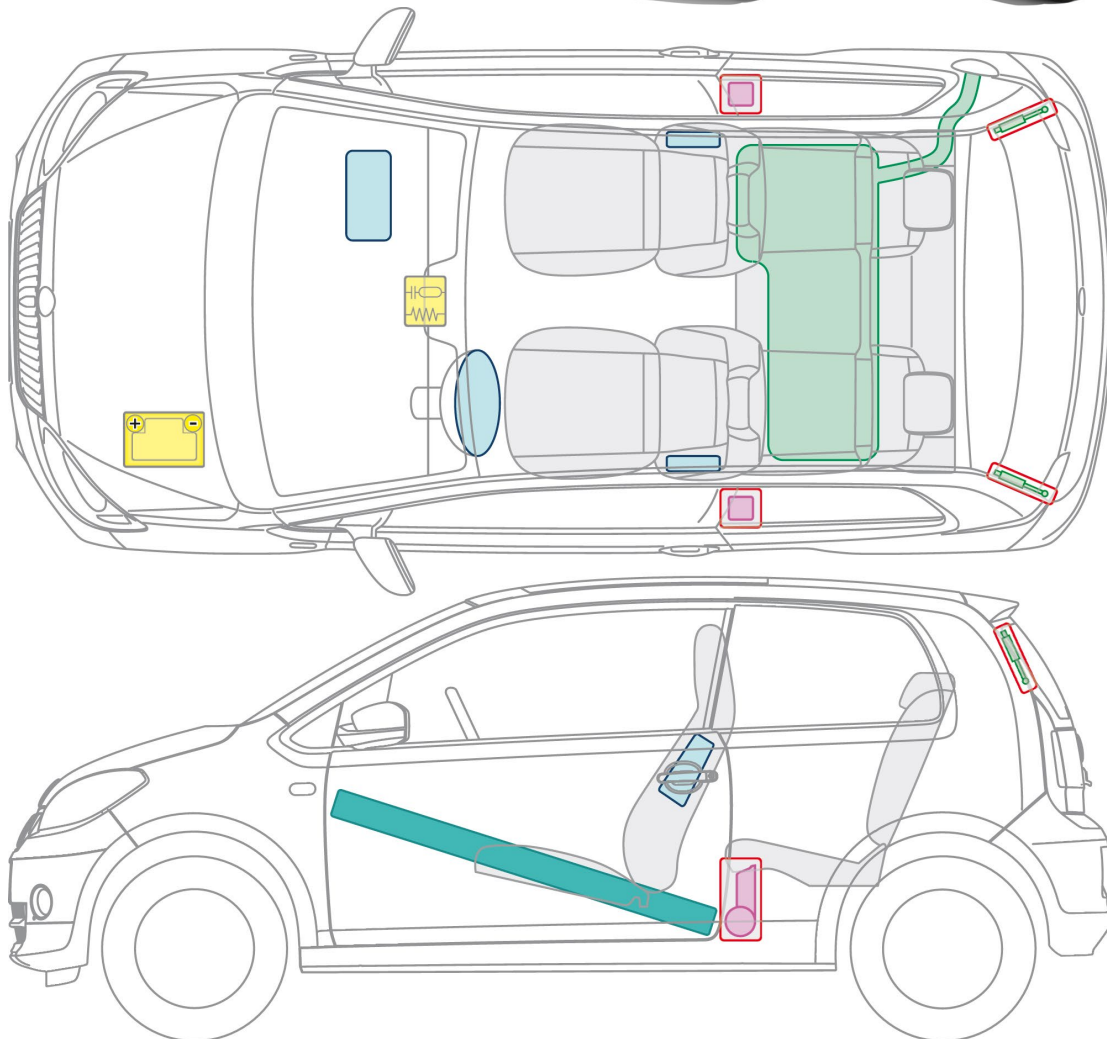

Allgemeine Informationen zur Rettung und Bergung finden Sie im Leitfaden für Rettungsdienste „Retten und Bergen aus verunfallten Fahrzeugen“ in der gleichnamigen Broschüre mit der Artikelnummer 500 5186 60 00.



Citigo 3-Türer ab 2011

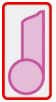

Legende

	Airbag		Karosserie- verstärkung		Steuergerät für Airbag
					Batterie
	Gurt- straffer		Gasdruck- dämpfer		Kraftstoff- tank







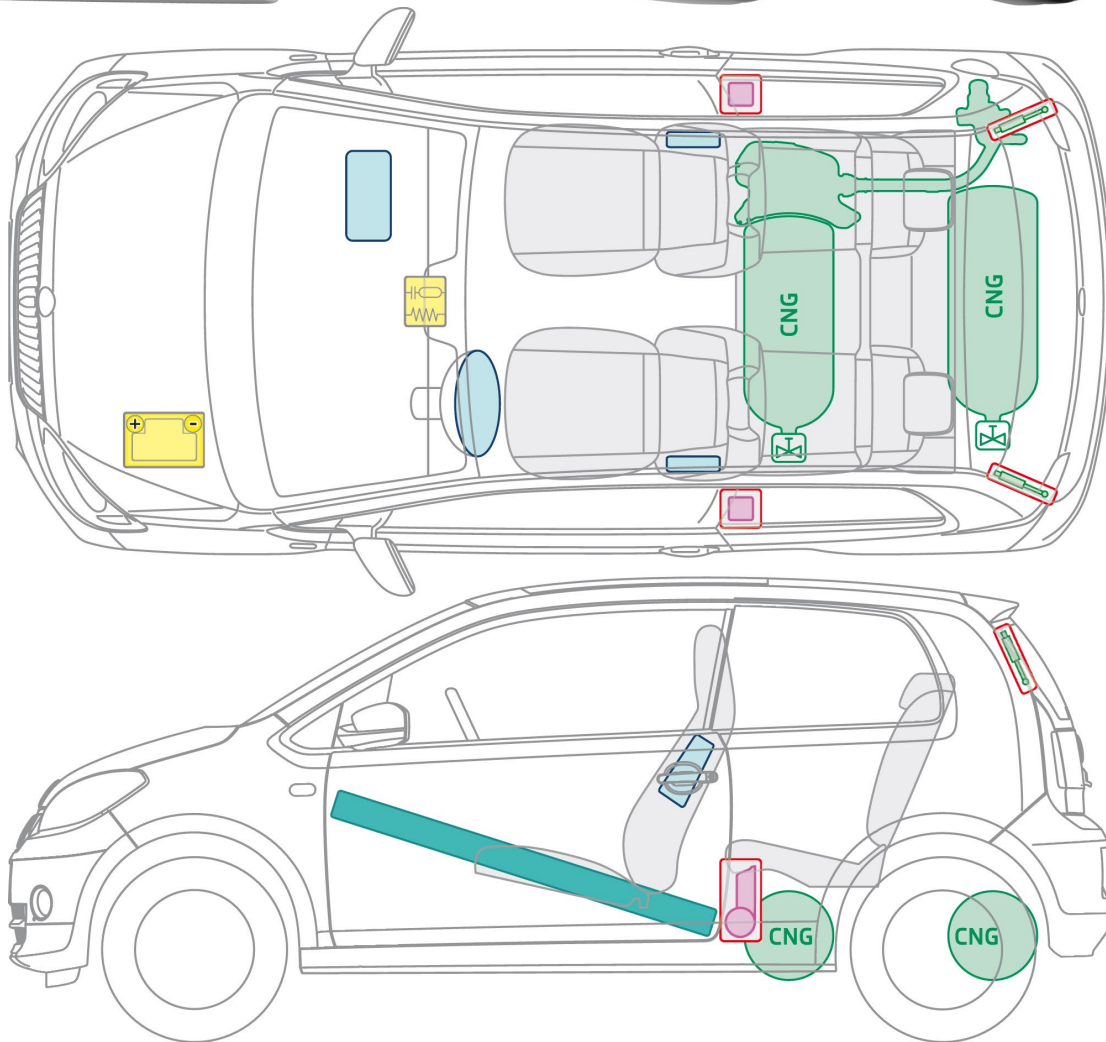

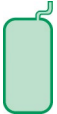

Citigo 3-Türer CNG ab 2012 Erdgasantrieb

CITIGO oder
G-TEC

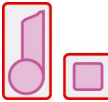

Legende





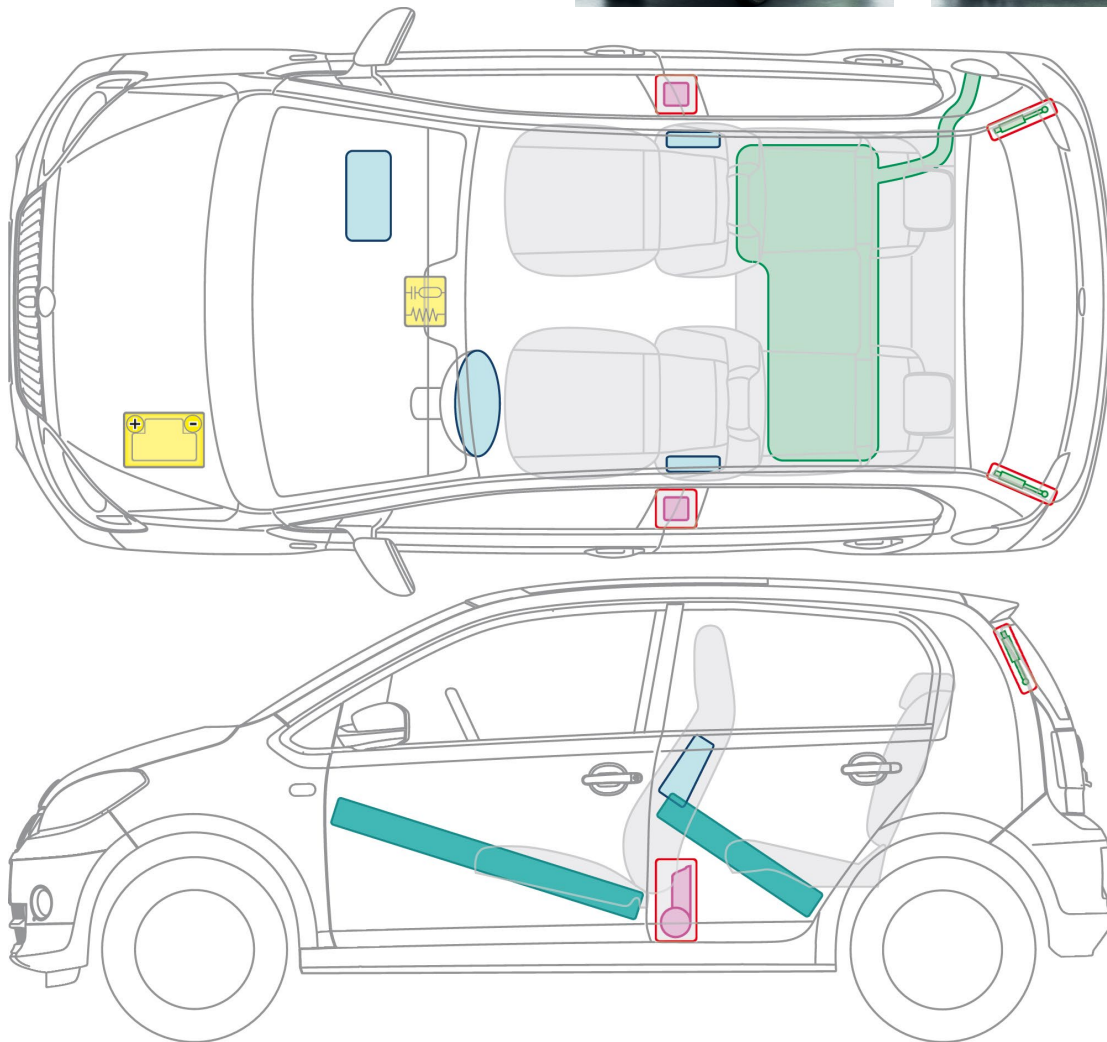

	Airbag		Karosserie- verstärkung		Kraftstoff- tank
	Batterie		Steuergerät für Airbag		Multifunktions- ventil
	Gurt- straffer		Gasdruck- dämpfer		



Citigo 5-Türer ab 2012

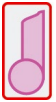

Legende

	Airbag		Karosserie- verstärkung		Steuergerät für Airbag
					Batterie
	Gurt- straffer		Gasdruck- dämpfer		Kraftstoff- tank







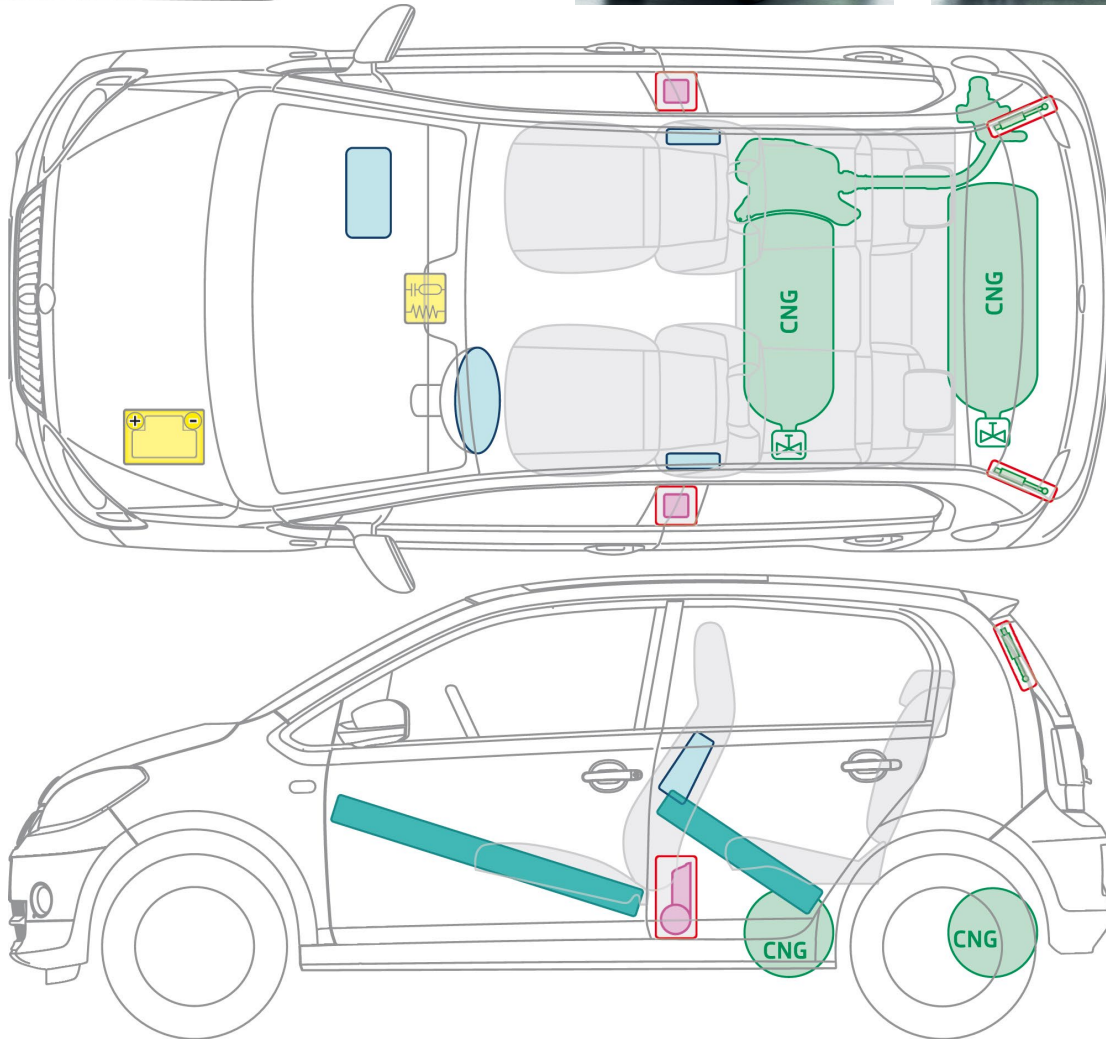

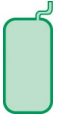

Citigo 5-Türer CNG ab 2012 Erdgasantrieb

CITIGO oder
G-TEC

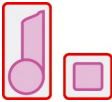

Legende





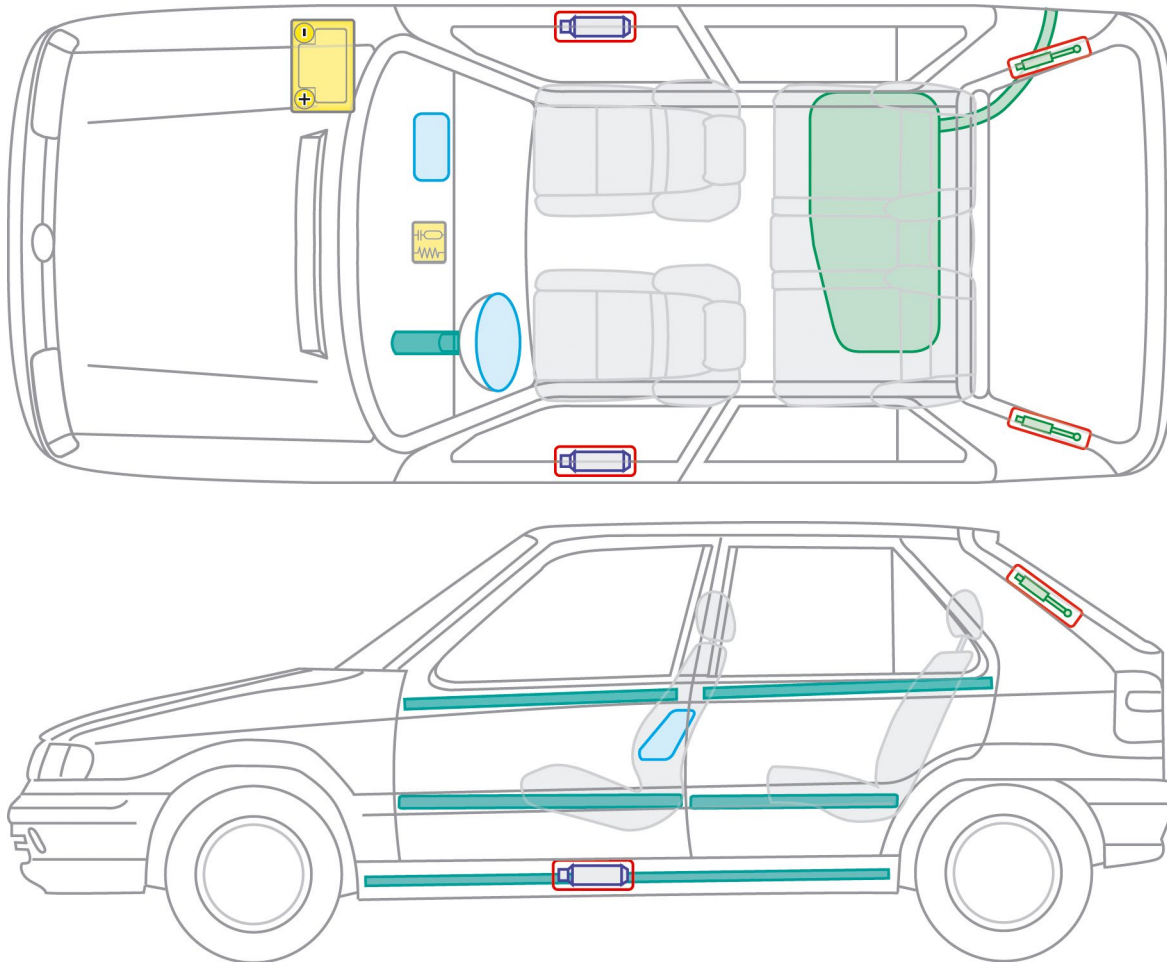

	Airbag		Karosserie- verstärkung		Kraftstoff- tank
	Batterie		Steuergerät für Airbag		Multifunktions- ventil
	Gurt- straffer		Gasdruck- dämpfer		

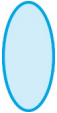

Felicia 1994 - 2001

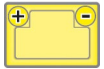

Legende

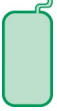



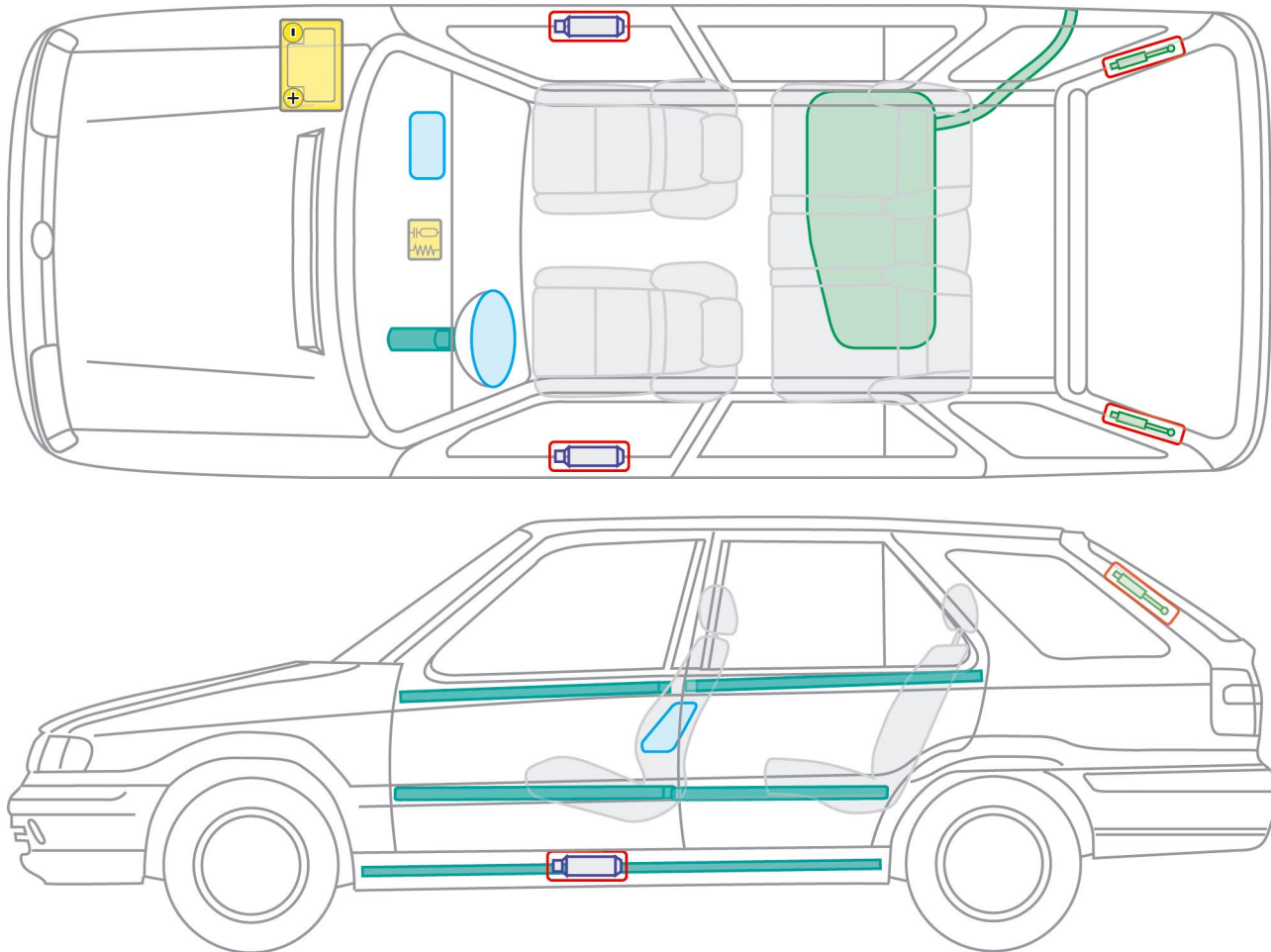

	Airbag		Karosserie- verstärkung		Steuergerät für Airbag
	Gas- generator		Batterie		Gasdruck- dämpfer
	Kraftstoff- tank				

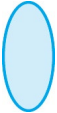

Felicia Combi 1995 - 2001

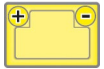

Legende

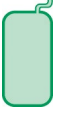



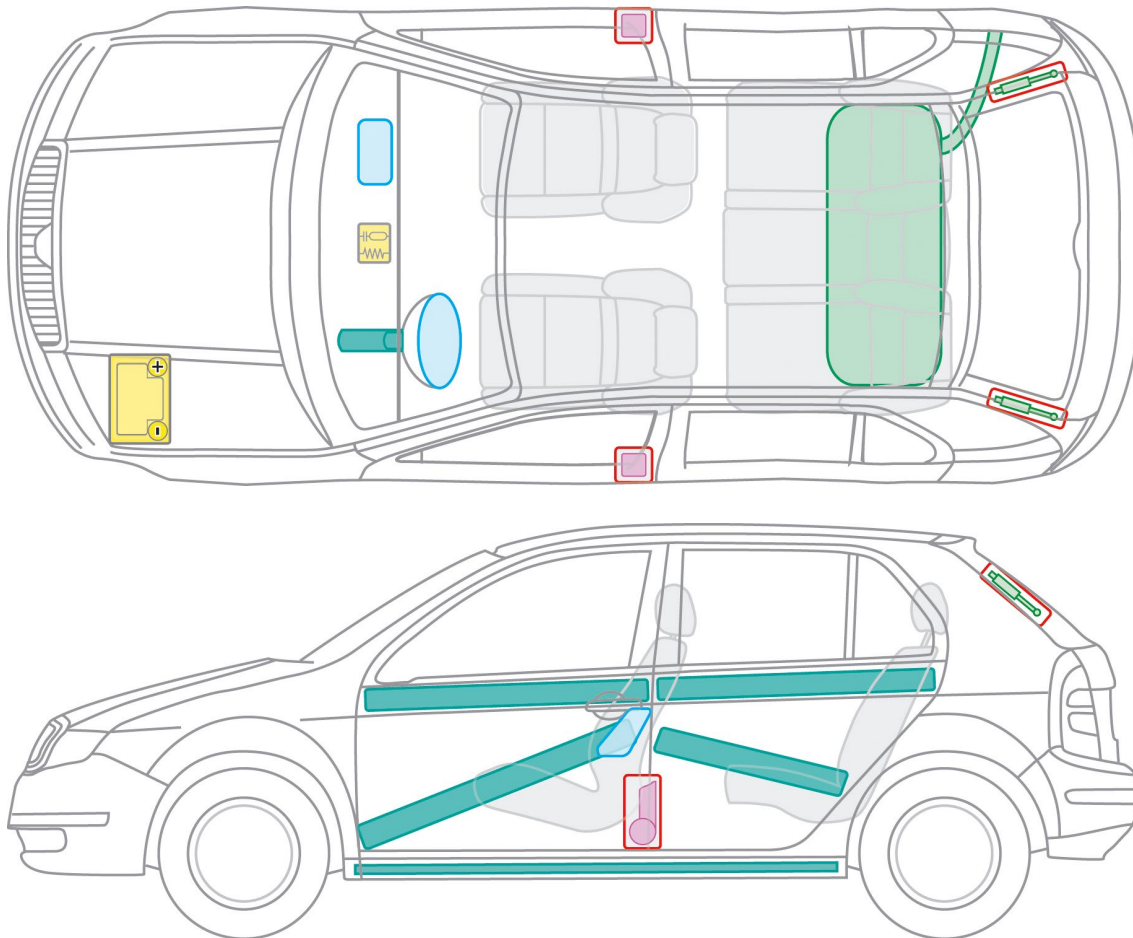

	Airbag		Karosserie- verstärkung		Steuergerät für Airbag
	Gas- generator		Batterie		Gasdruck- dämpfer
	Kraftstoff- tank				

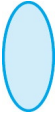

Fabia I 1999 - 2007

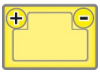

Legende





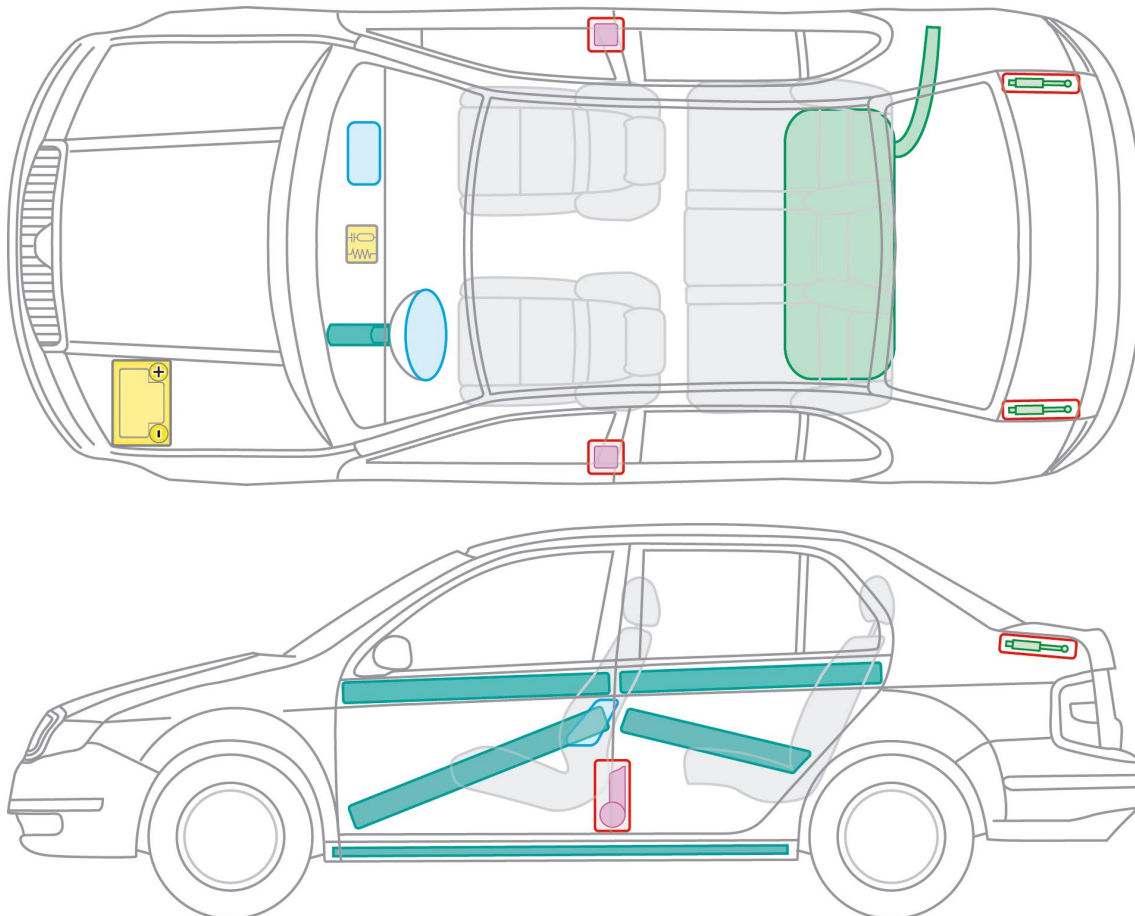

	Airbag		Karosserie- verstärkung		Steuergerät für Airbag
	Batterie		Gurt- straffer		Gasdruck- dämpfer
	Kraftstoff- tank				

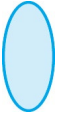

Fabia Sedan I 2001 - 2008

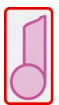

Legende





	Airbag		Karosserie- verstärkung		Steuergerät für Airbag
	Batterie		Gurt- straffer		Gasdruck- dämpfer
	Kraftstoff- tank				

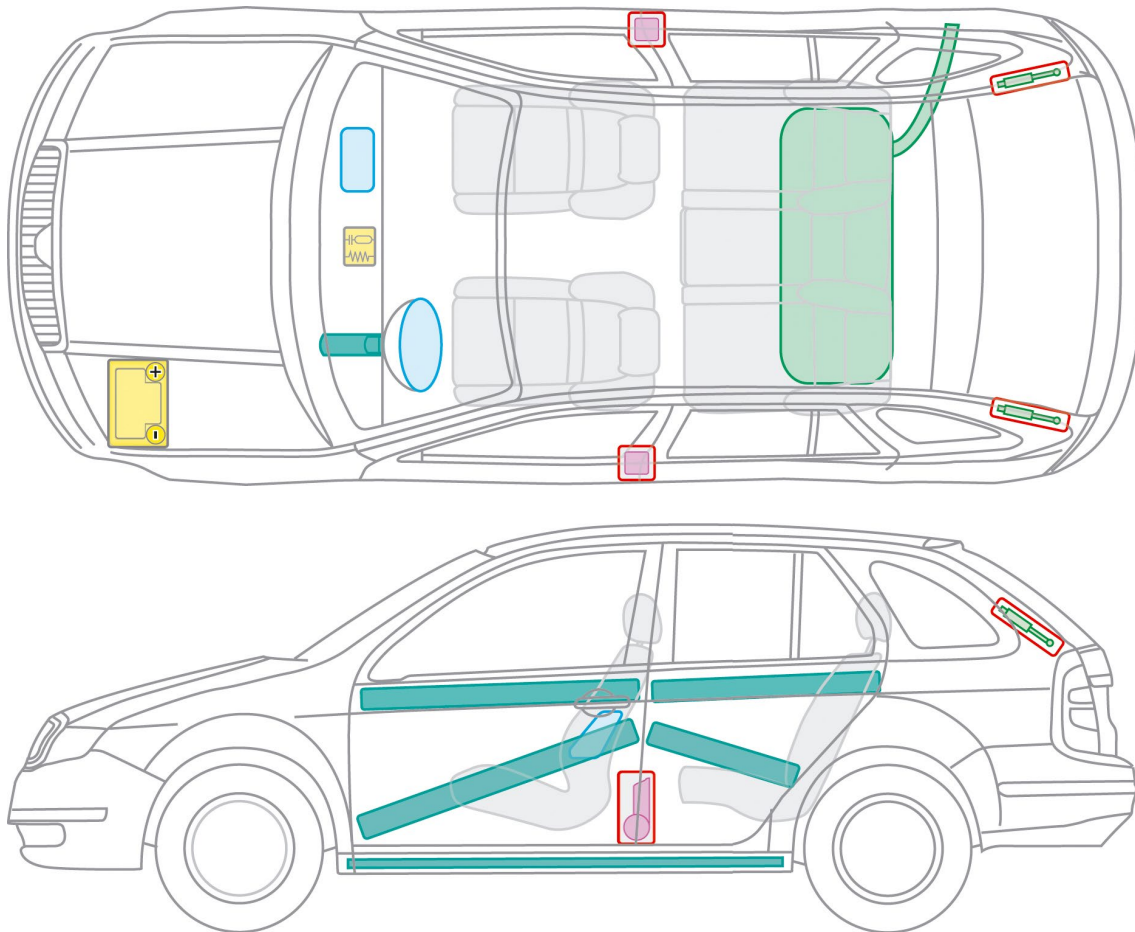

Fabia Combi I 2000 - 2007

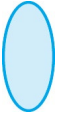

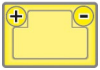
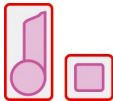
Legende





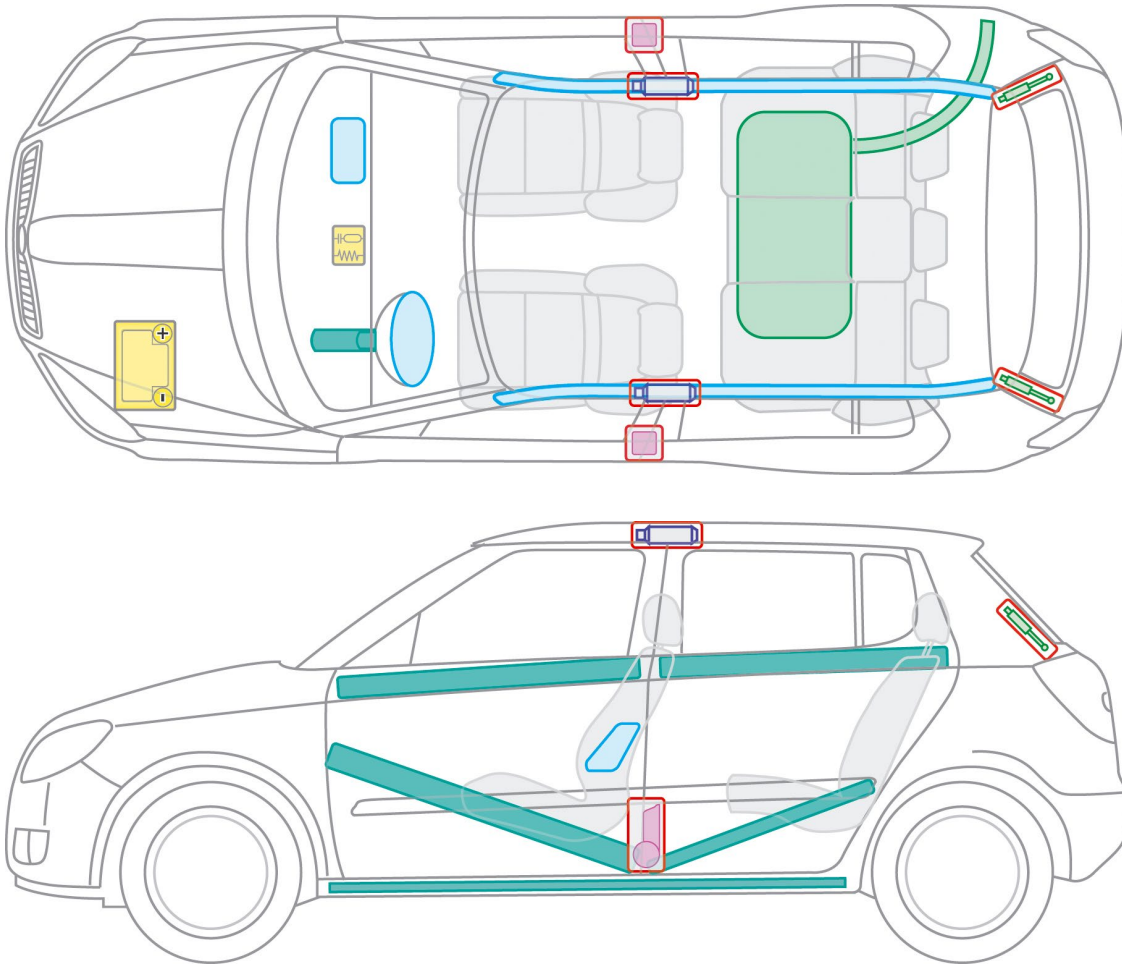

 <p>Airbag</p>	 <p>Karosserie- verstärkung</p>	 <p>Steuergerät für Airbag</p>
 <p>Batterie</p>	 <p>Gurt- straffer</p>	 <p>Gasdruck- dämpfer</p>
 <p>Kraftstoff- tank</p>		

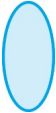

Fabia II 2006 - 2014

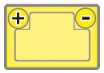
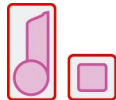

Legende

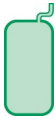



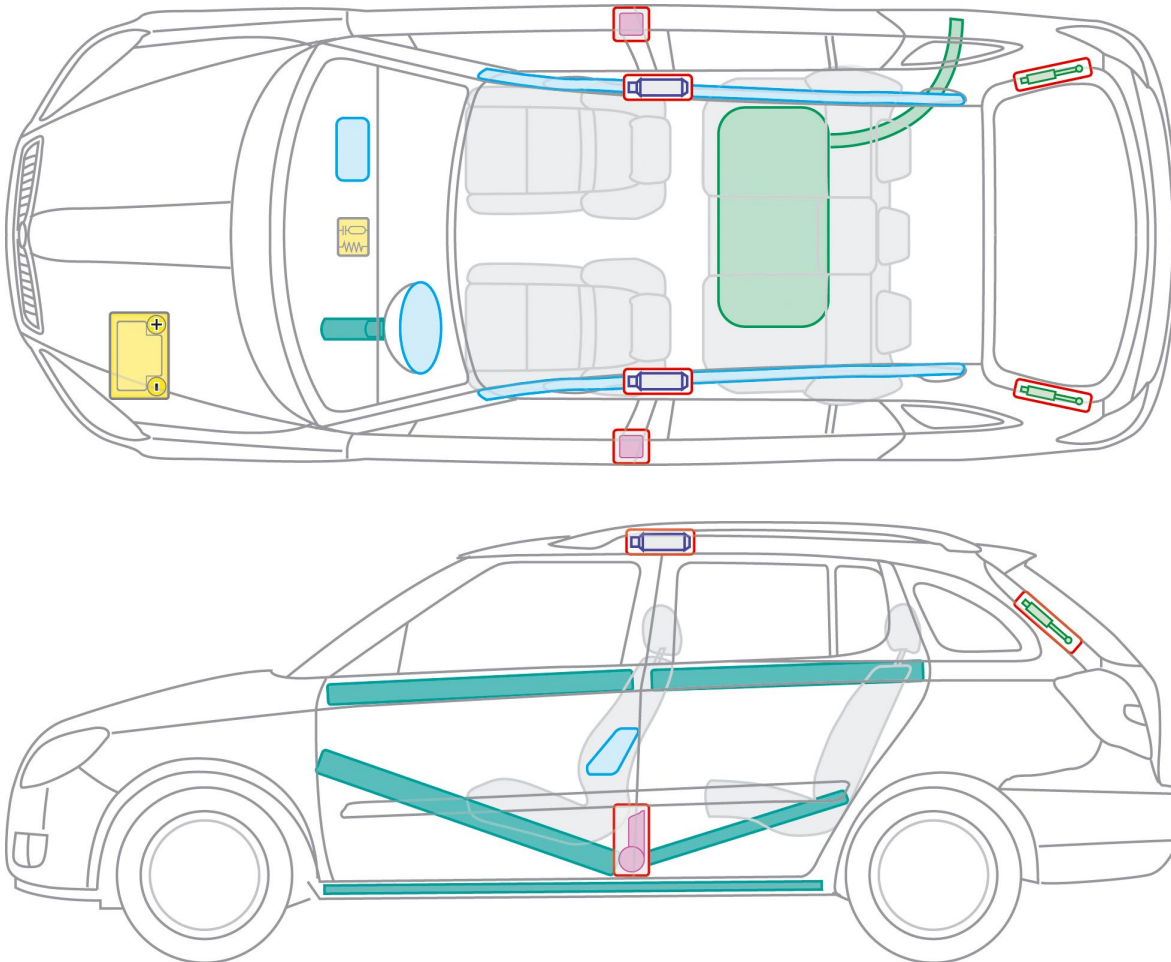

	Airbag		Karosserie- verstärkung		Steuergerät für Airbag
	Gas- generator		Batterie		Gurt- straffer
	Gasdruck- dämpfer		Kraftstoff- tank		

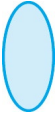

Fabia Combi II 2006 - 2014

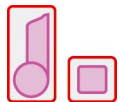

Legende

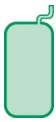



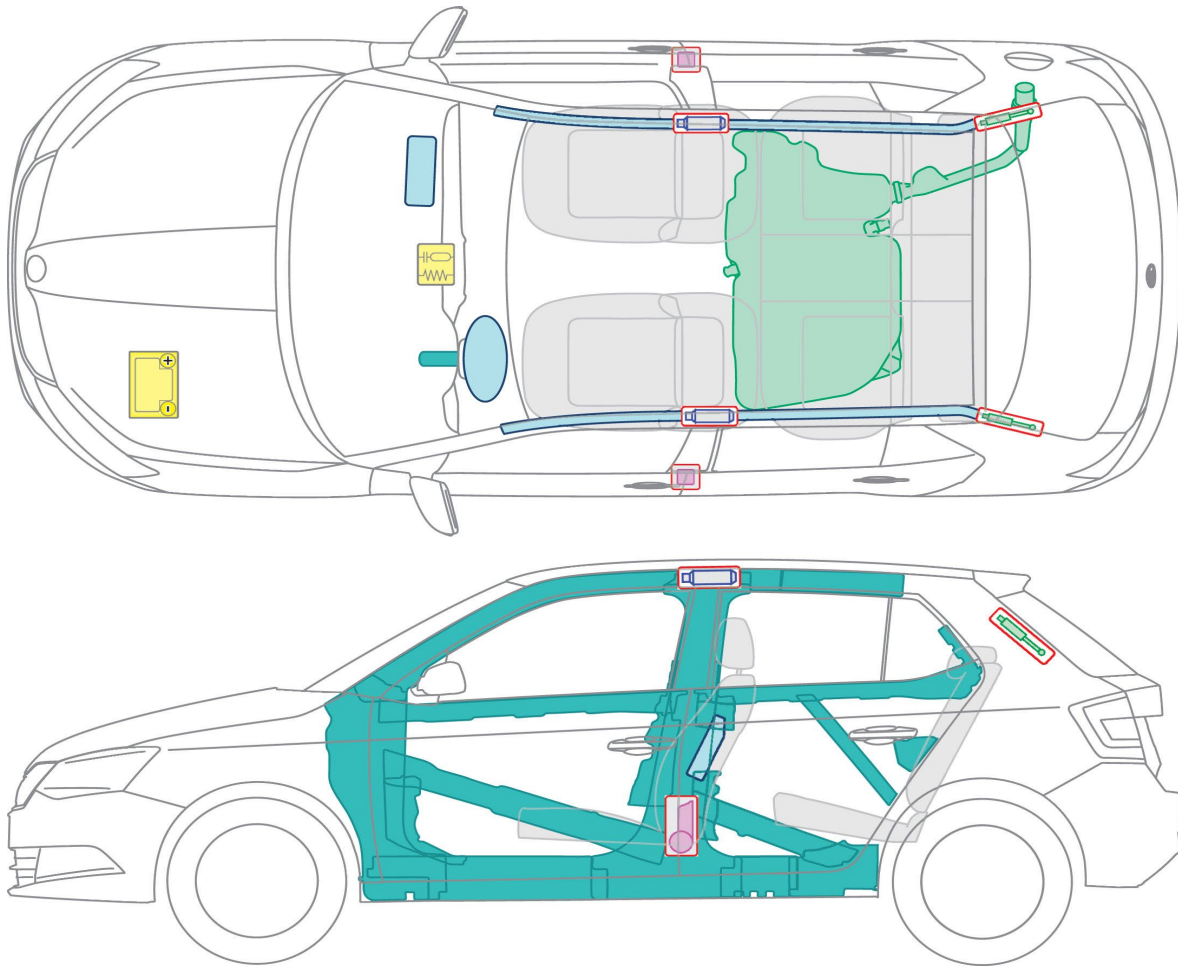

	Airbag		Karosserie- verstärkung		Steuergerät für Airbag
	Gas- generator		Batterie		Gurt- straffer
	Gasdruck- dämpfer		Kraftstoff- tank		

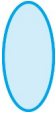

Fabia III ab 2014

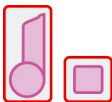

Legende

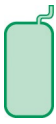



	Airbag		Karosserie- verstärkung		Steuergerät für Airbag
	Gas- generator		Batterie		Gurt- straffer
	Gasdruck- dämpfer		Kraftstoff- tank		

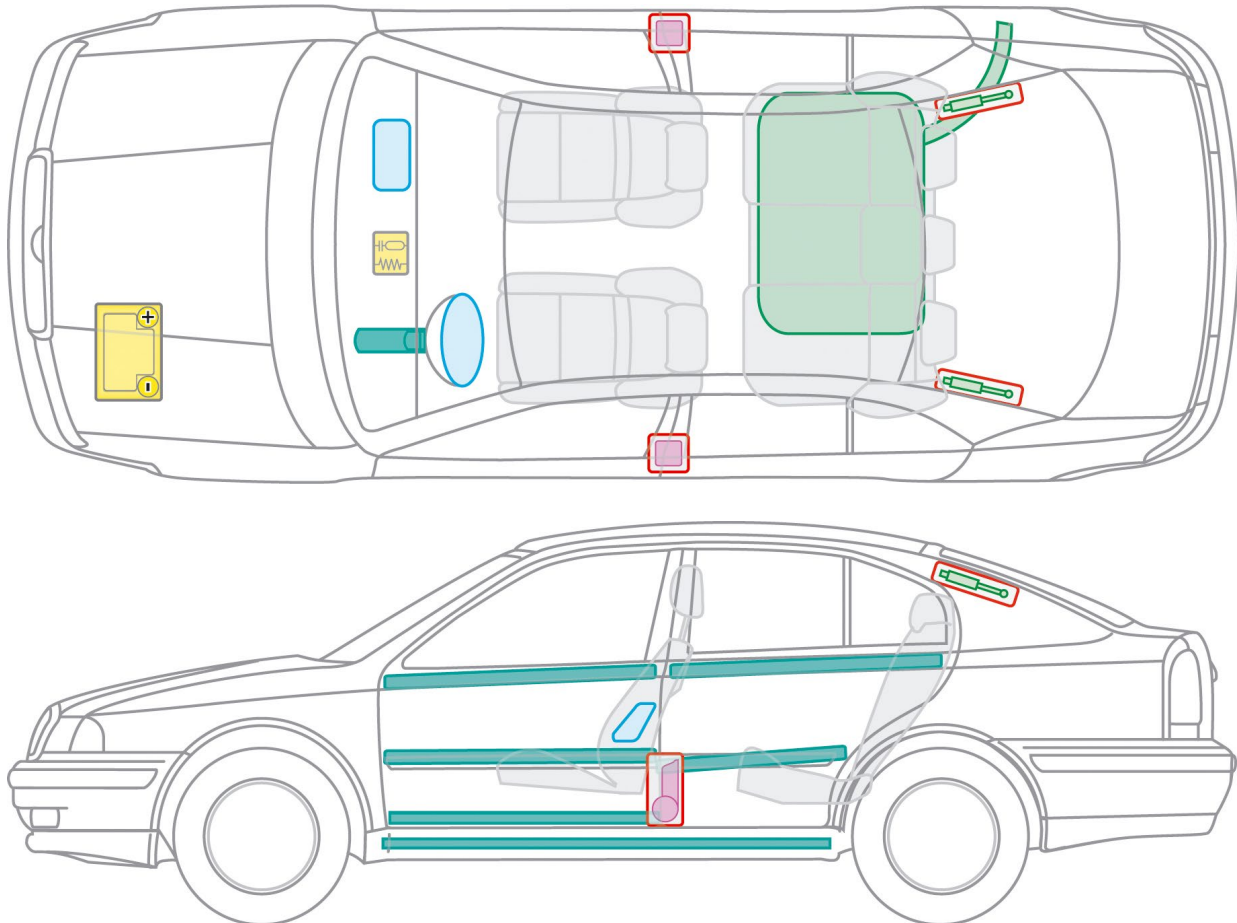

Octavia I 1996 - 2010

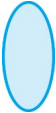

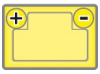
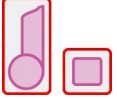
Legende





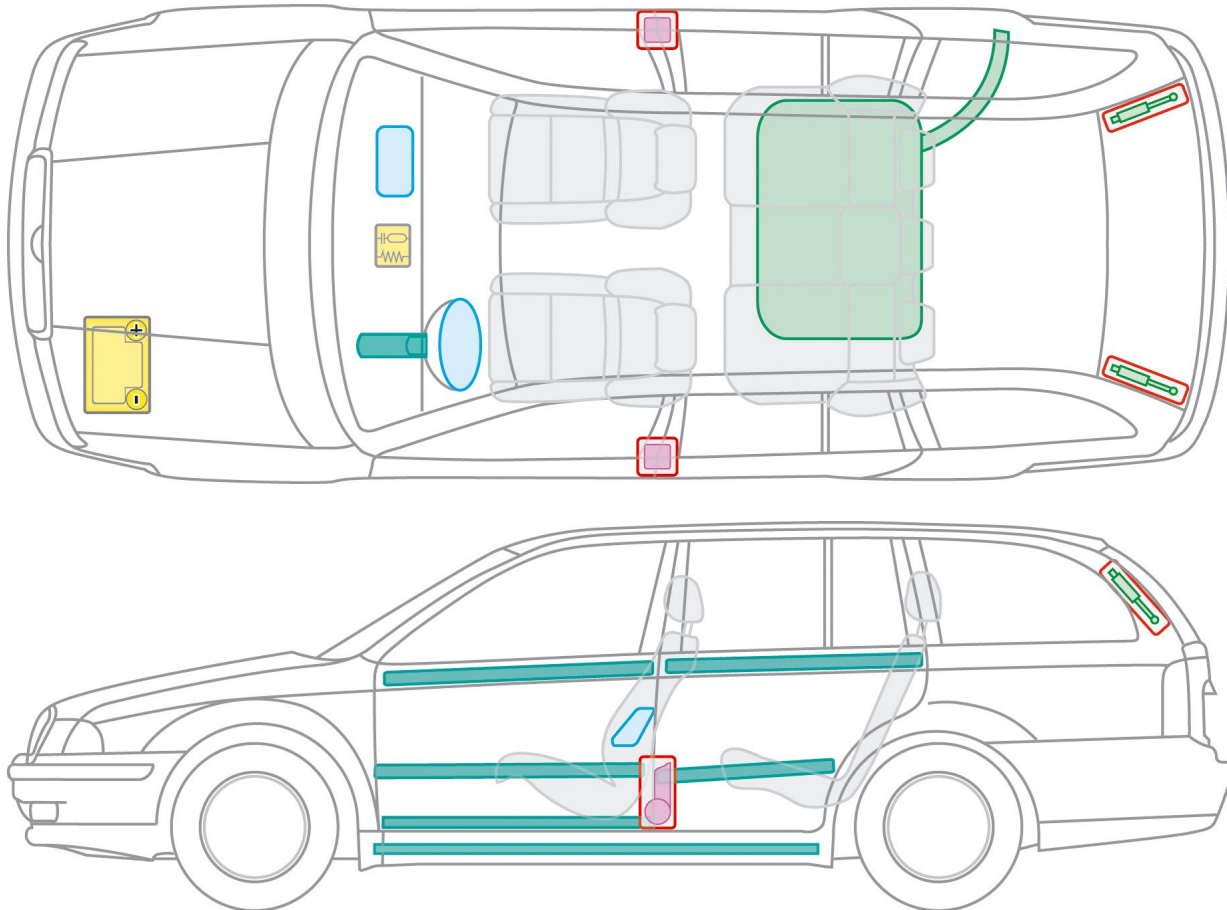

	Airbag		Karosserie- verstärkung		Steuergerät für Airbag
	Batterie		Gurt- straffer		Gasdruck- dämpfer
	Kraftstoff- tank				

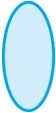

Octavia Combi I 2000 - 2010

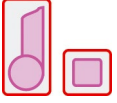

Legende





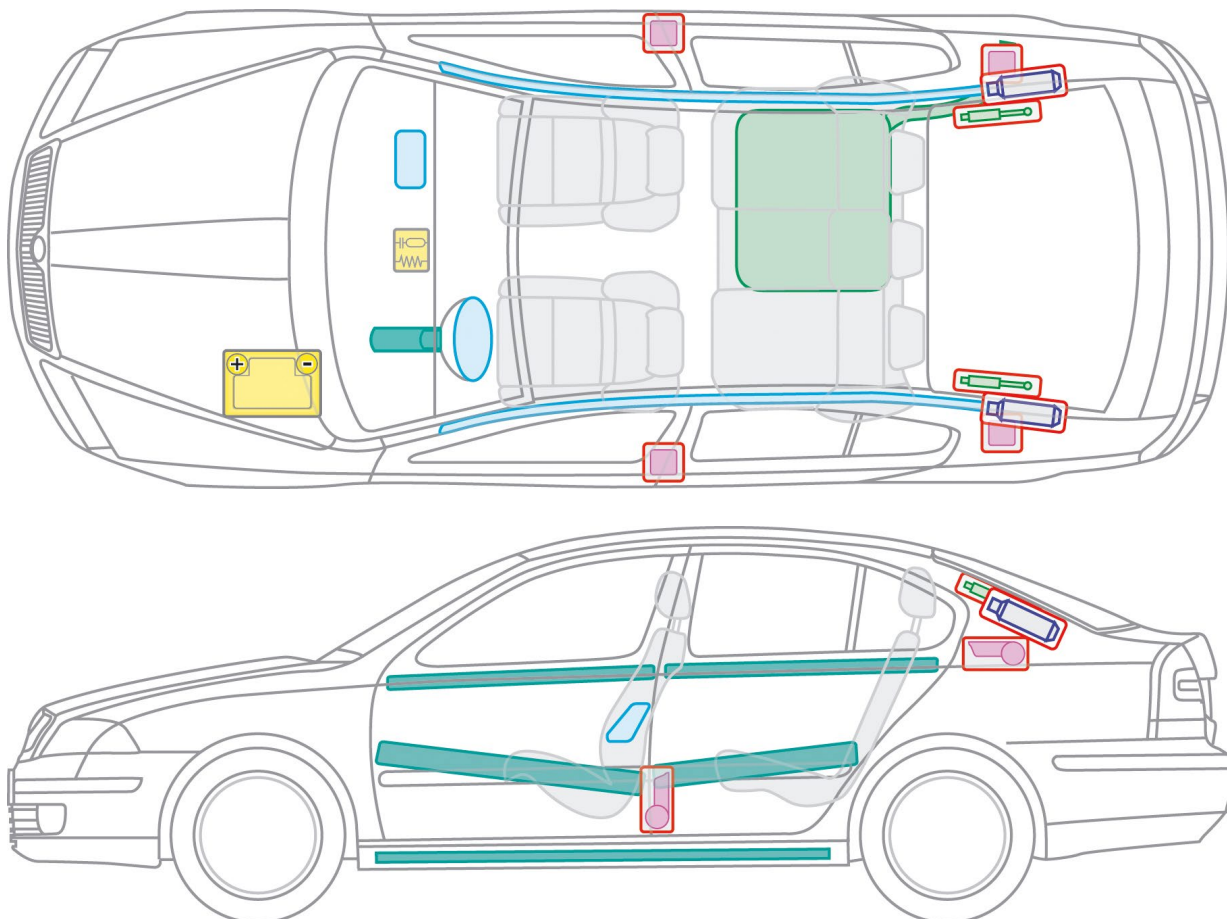

	Airbag		Karosserie- verstärkung		Steuergerät für Airbag
	Batterie		Gurt- straffer		Gasdruck- dämpfer
	Kraftstoff- tank				



Octavia II 2004 - 2013

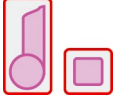

Legende





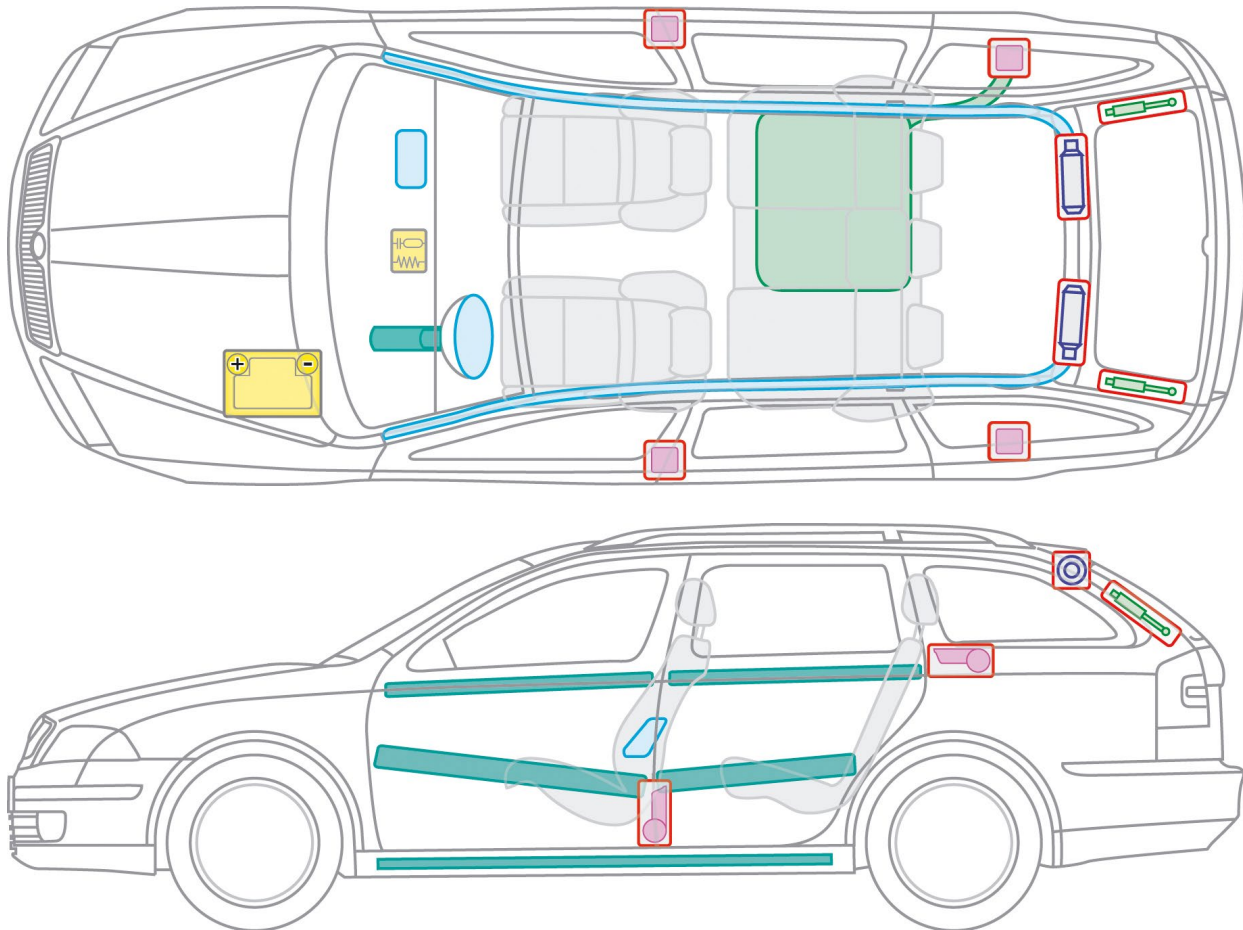

	Airbag		Karosserie- verstärkung		Steuergerät für Airbag
	Gas- generator		Batterie		Gurt- straffer
	Gasdruck- dämpfer		Kraftstoff- tank		

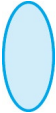

Octavia Combi II 2004 - 2013

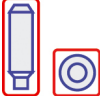
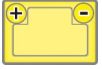
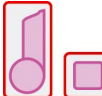
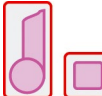

Legende

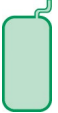
	Airbag		Karosserie- verstärkung		Batterie		Steuergerät für Airbag
	Gas- generator		Batterie		Gas- straffer		Gurt- straffer
	Gasdruck- dämpfer		Kraftstoff- tank				









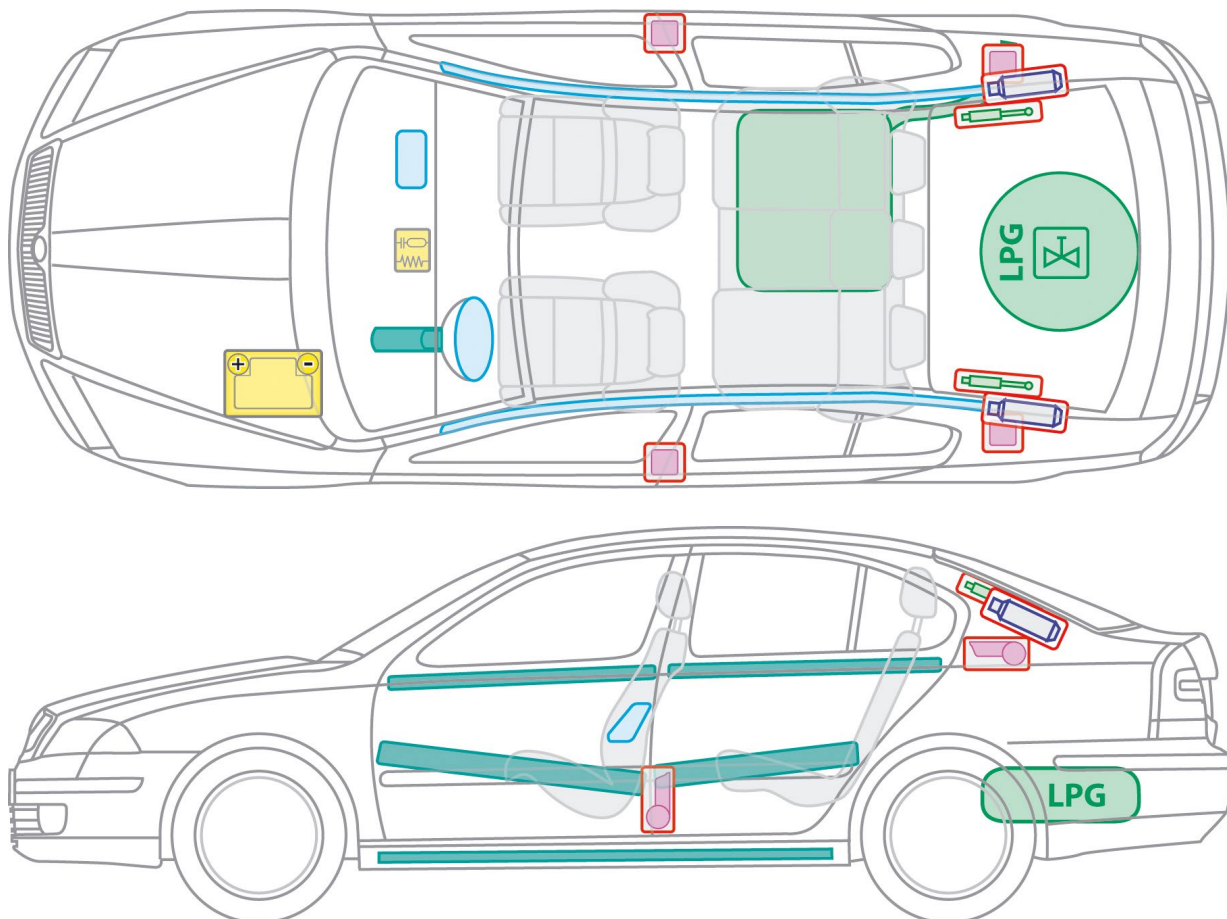

Octavia II LPG 2009 -2013

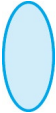
Flüssiggasantrieb

MPI

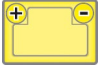
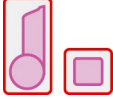

Legende

	Airbag		Karosserie- verstärkung		Steuergerät für Airbag
	Gas- generator		Batterie		Gurt- straffer
	Gasdruck- dämpfer		Kraftstoff- tank		Multifunktions- ventil









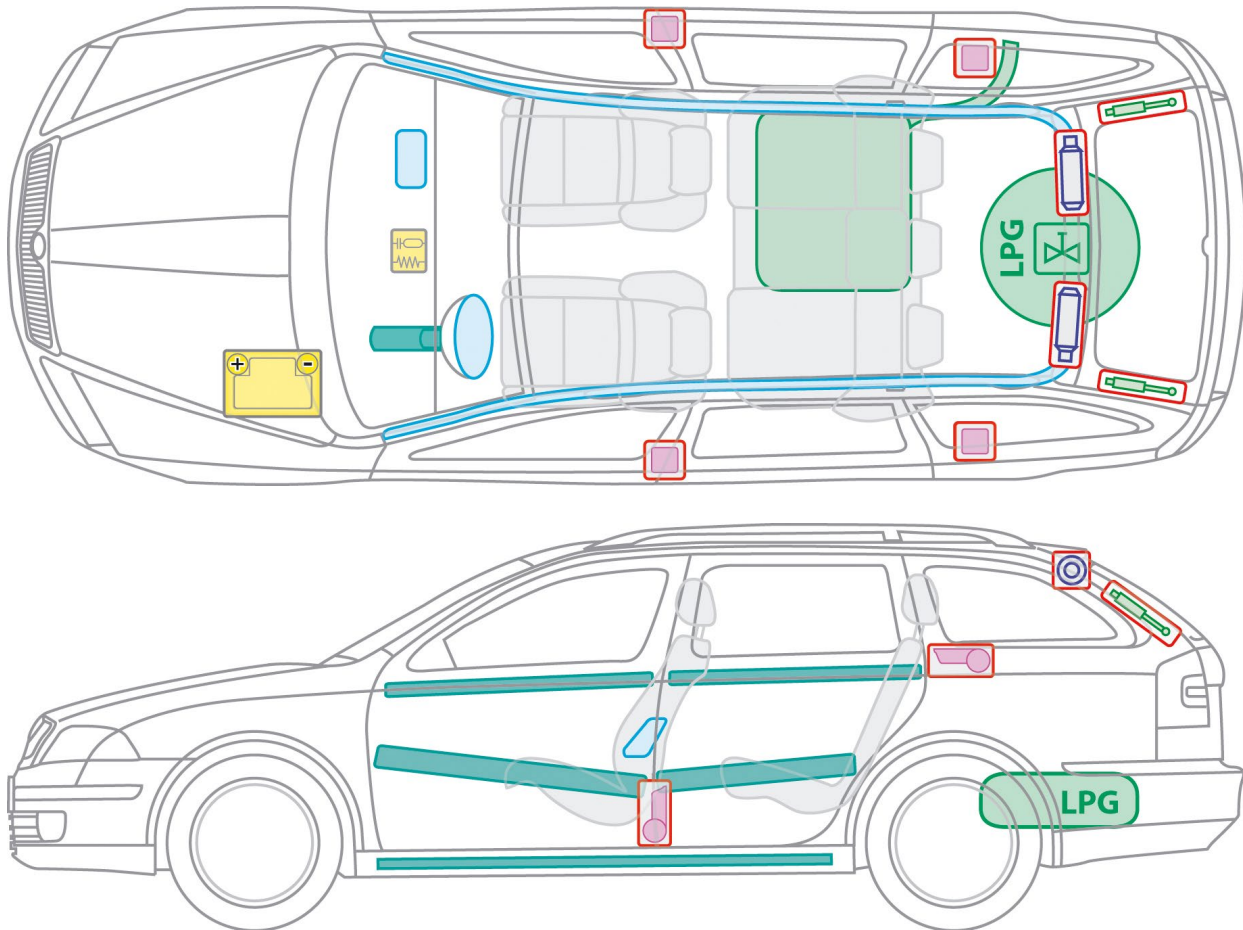

Octavia Combi II LPG 2009 - 2013

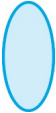
Flüssiggasantrieb

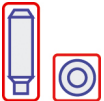
MPI

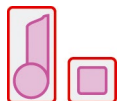

Legende







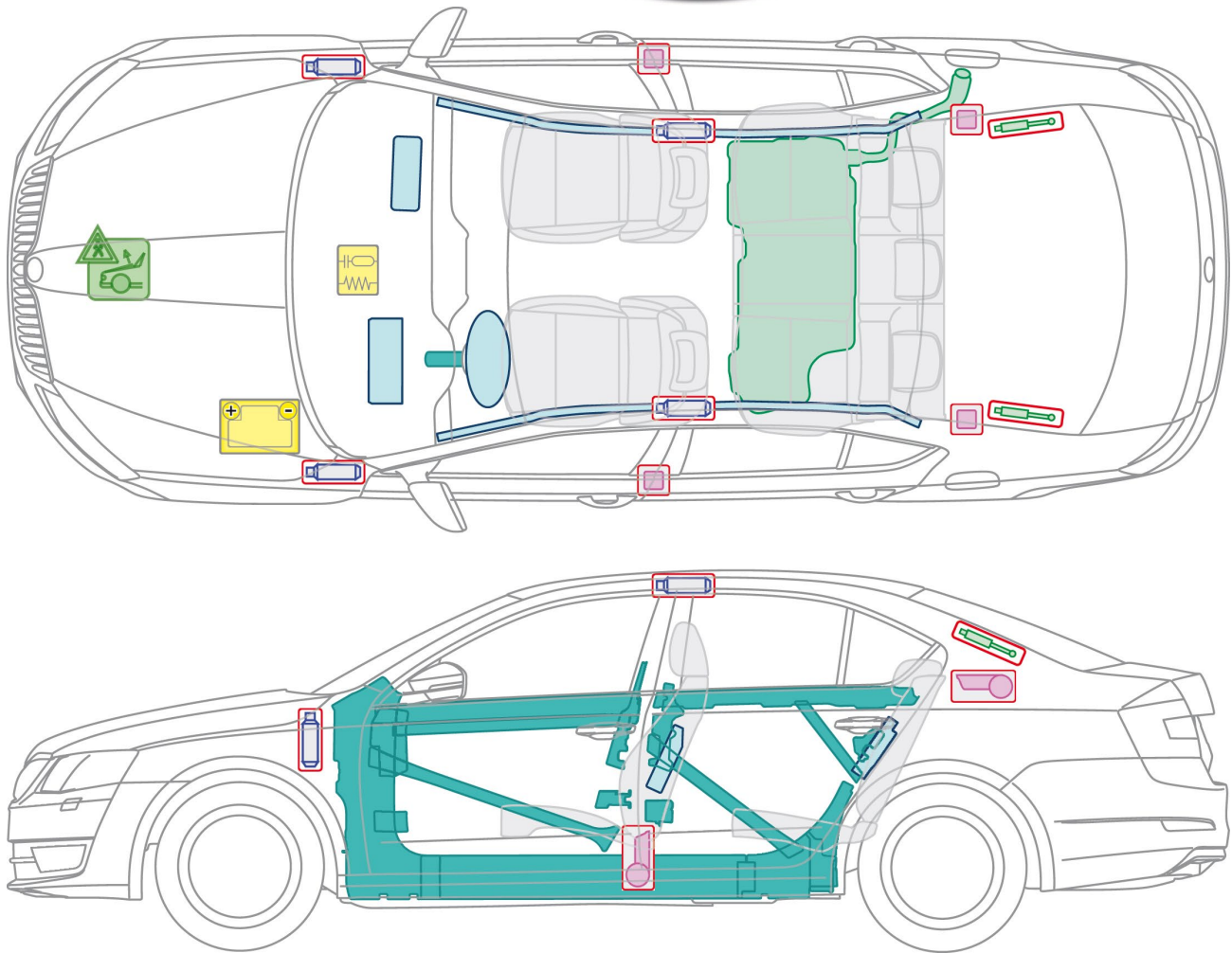

	Airbag		Karosserie- verstärkung		Steuergerät für Airbag
	Gas- generator		Batterie		Gurt- straffer
	Gasdruck- dämpfer		Kraftstoff- tank		Multifunktions- ventil



Octavia III ab 2012

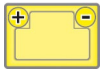
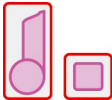

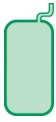
Legende

	Airbag		Karosserie- verstärkung		Steuergerät für Airbag
	Gas- generator		Batterie		Gurt- straffer
	Gasdruck- dämpfer		Kraftstoff- tank		Fußgängerschutz- system Bis KW 21/2013







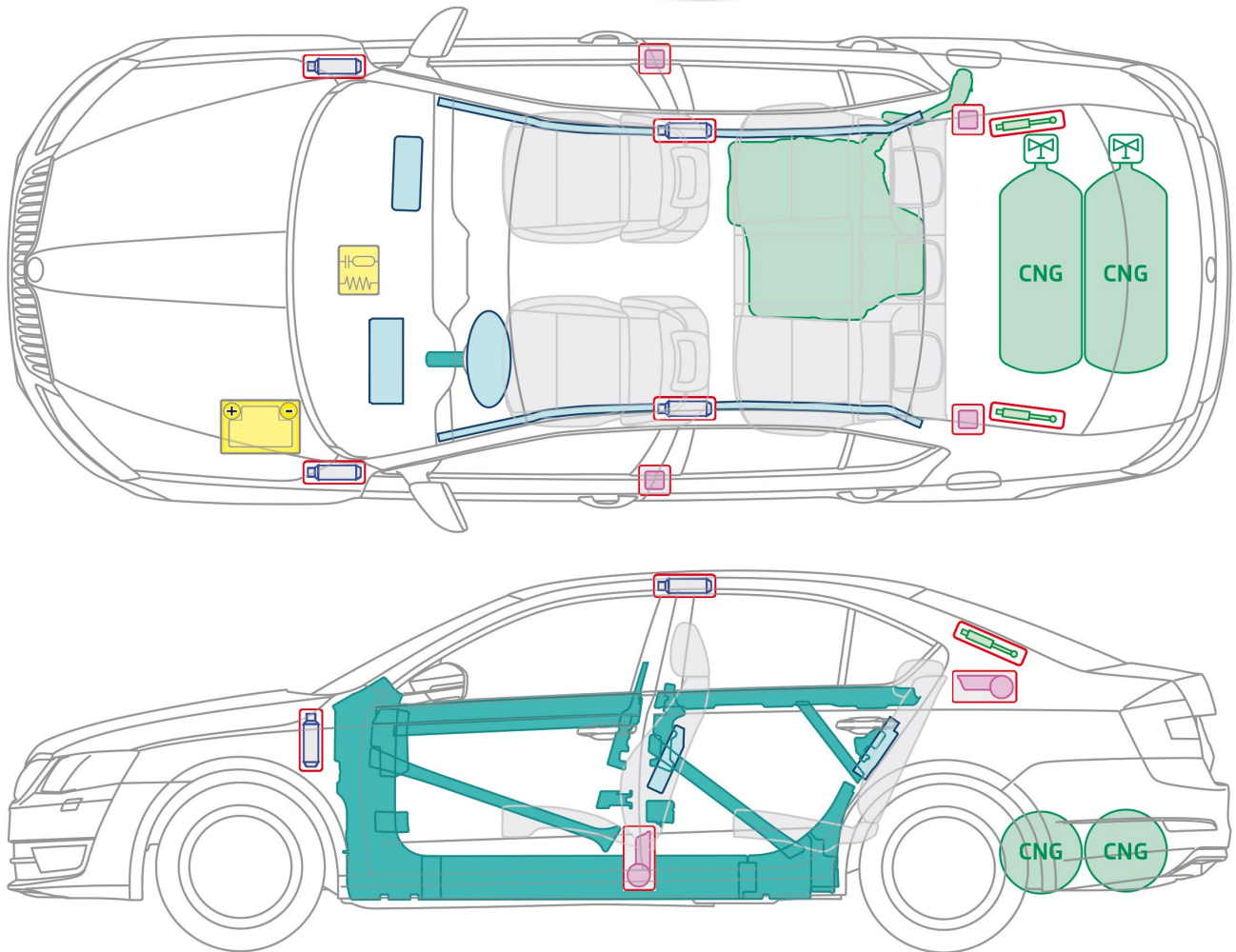



Octavia III CNG ab 2014

Erdgasantrieb

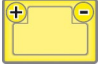
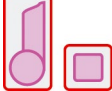

Legende







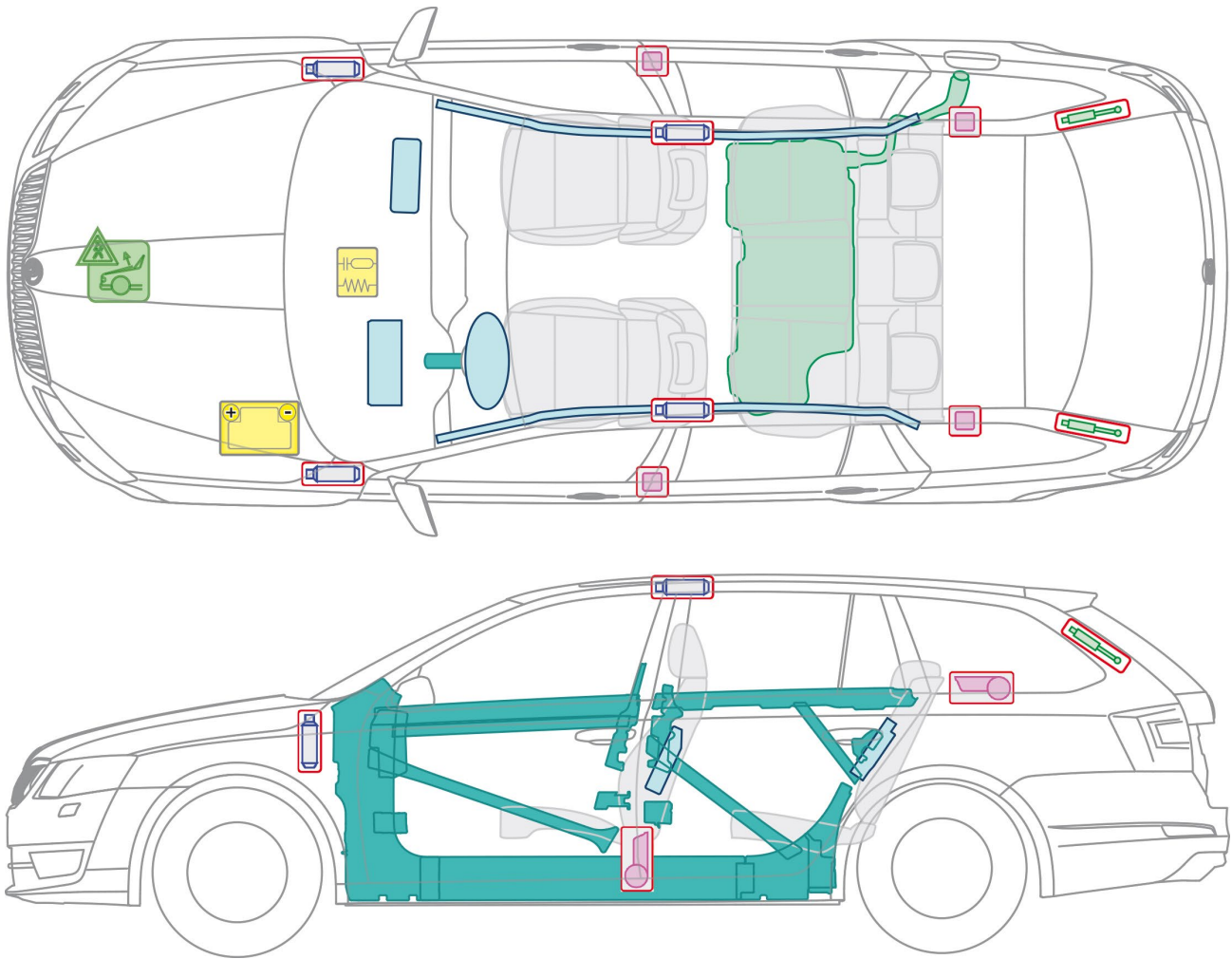

	Airbag		Karosserie- verstärkung		Steuergerät für Airbag
	Gas- generator		Batterie		Gurt- straffer
	Gasdruck- dämpfer		Kraftstoff- tank		Multifunktions- ventil



Octavia Combi III ab 2013

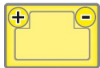
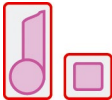

Legende

	Airbag		Karosserie- verstärkung		Steuergerät für Airbag
	Gas- generator		Batterie		Gurt- straffer
	Gasdruck- dämpfer		Kraftstoff- tank		Fußgängerschutz- system Bis KW 21/2013







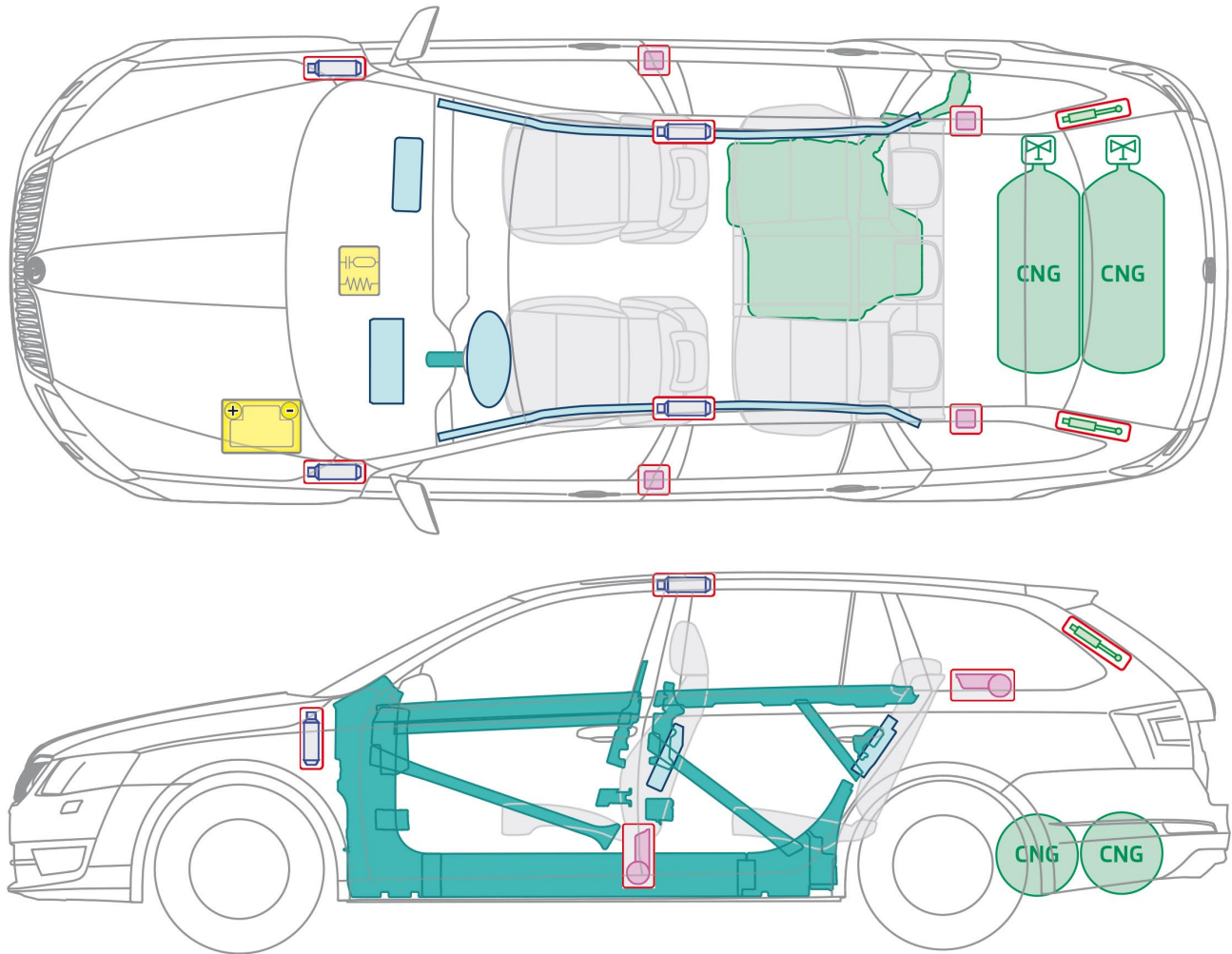



Octavia Combi III CNG ab 2014

Erdgasantrieb

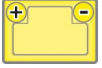
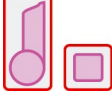

Legende





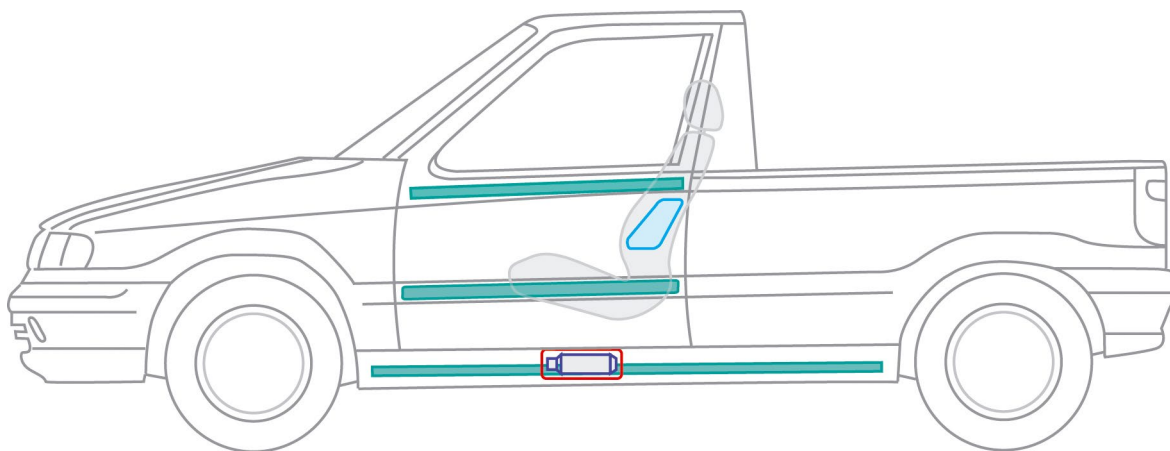
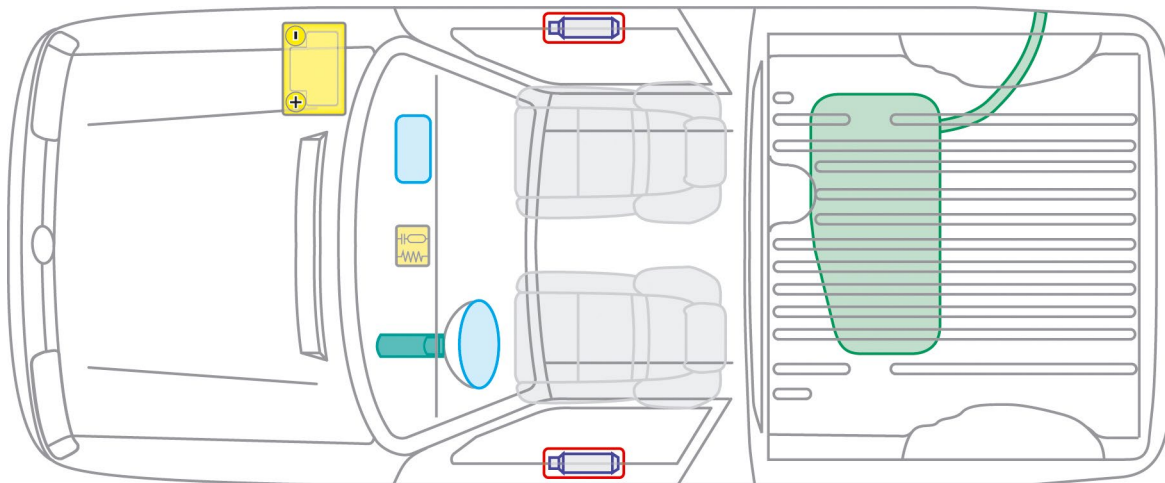

	Airbag		Karosserie- verstärkung		Steuergerät für Airbag
	Gas- generator		Batterie		Gurt- straffer
	Gasdruck- dämpfer		Kraftstoff- tank		Multifunktions- ventil

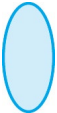

Pick up 1995 - 2001

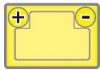

Legende







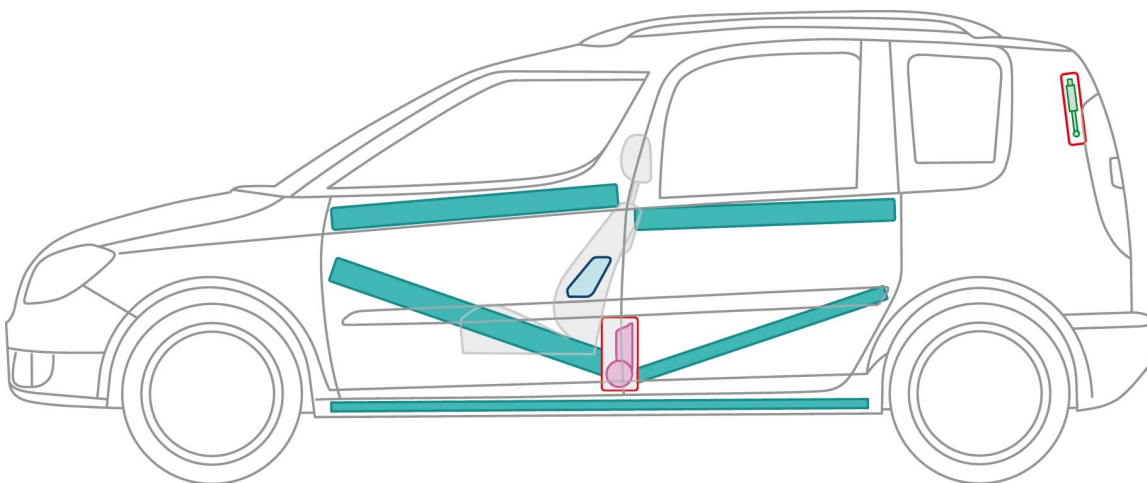
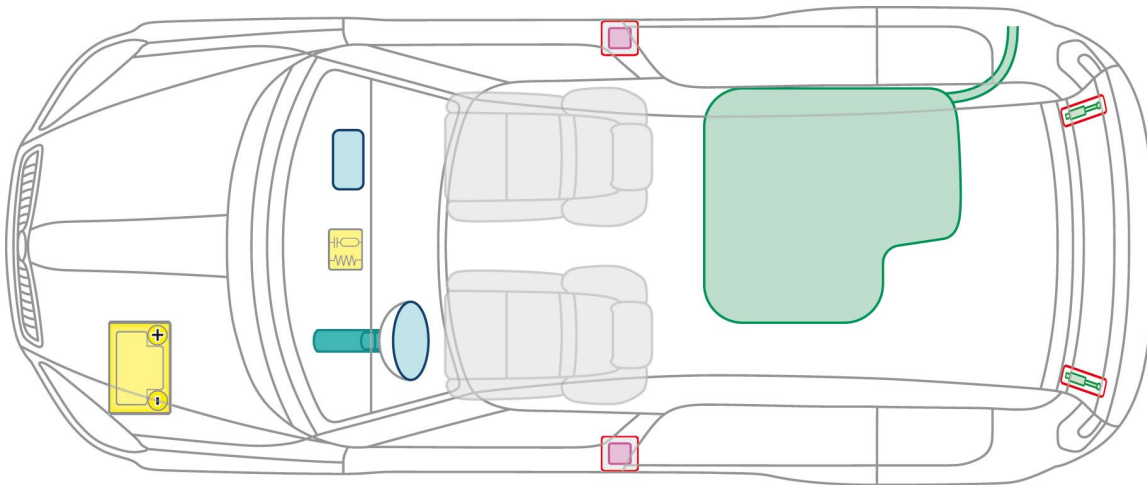

	Airbag		Karosserie- verstärkung		Steuergerät für Airbag
	Gas- generator		Batterie		Gasdruck- dämpfer
	Kraftstoff- tank				

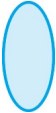

Praktik ab 2006

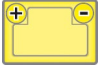

Legende





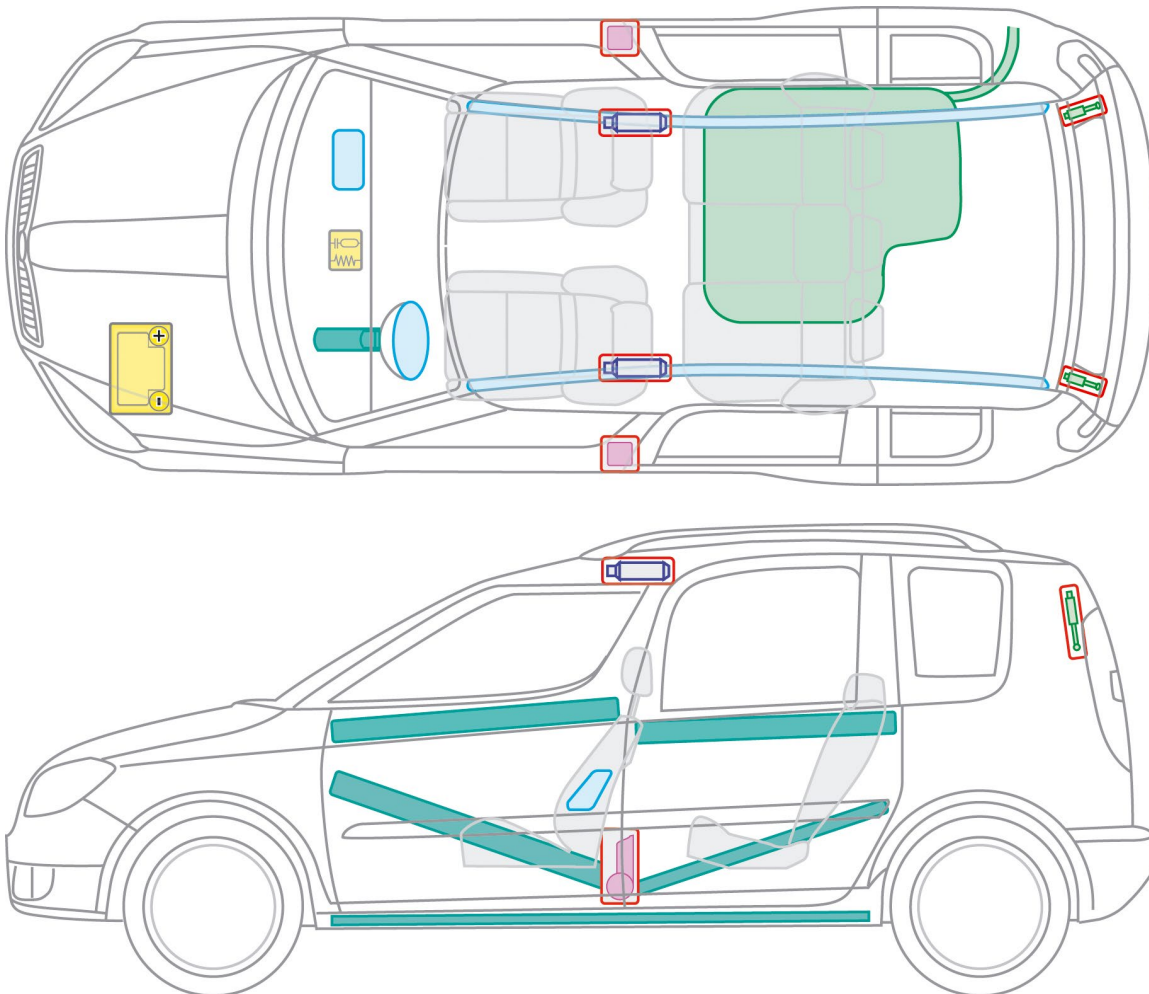

	Airbag		Karosserie- verstärkung		Steuergerät für Airbag
	Gas- generator		Batterie		Gurt- straffer
	Gasdruck- dämpfer		Kraftstoff- tank		

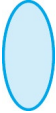

Roomster ab 2006

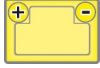
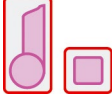

Legende

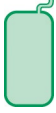



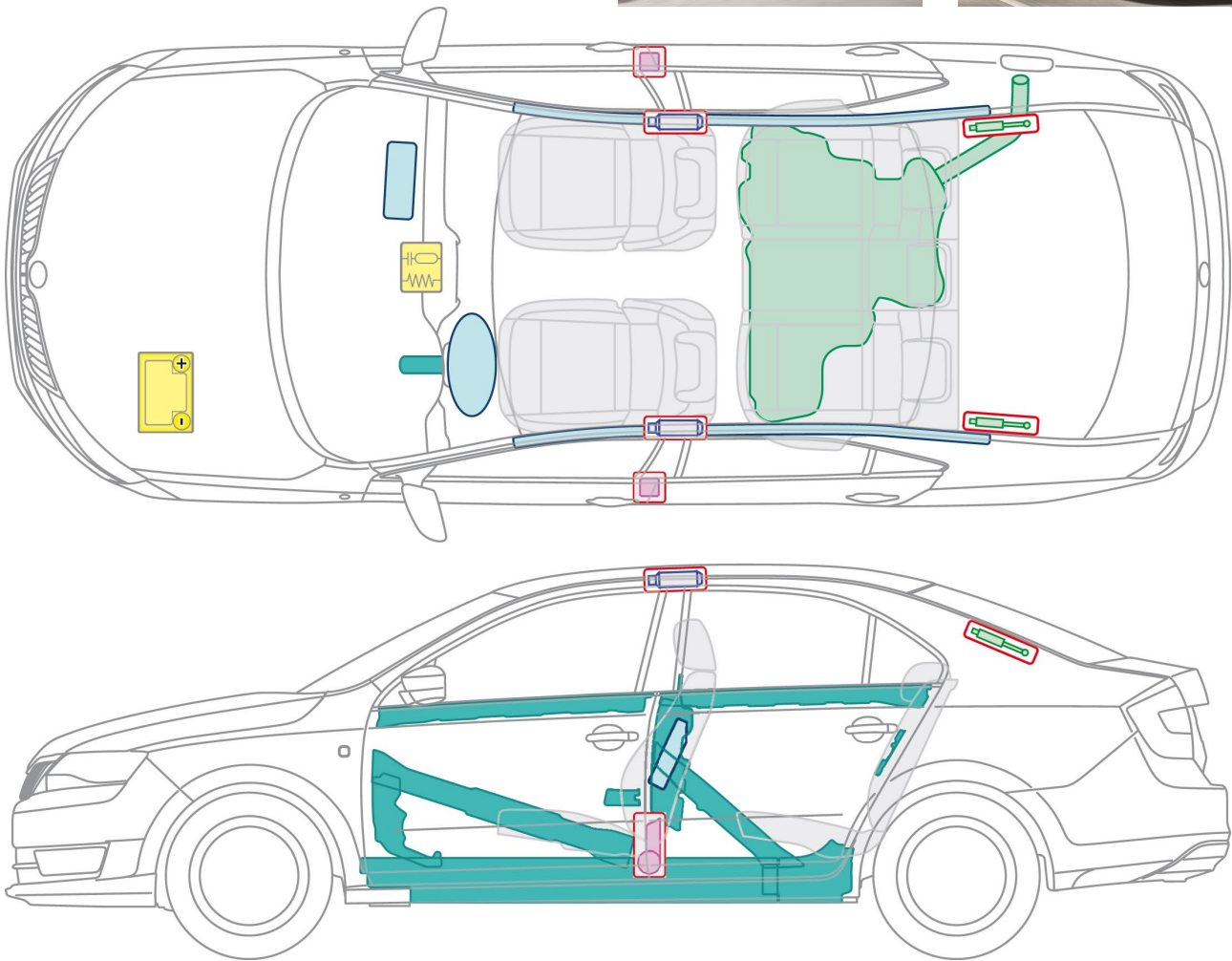

	Airbag		Karosserie- verstärkung		Steuergerät für Airbag
	Gas- generator		Batterie		Gurt- straffer
	Gasdruck- dämpfer		Kraftstoff- tank		



Rapid ab 2012

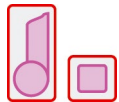

Legende

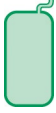



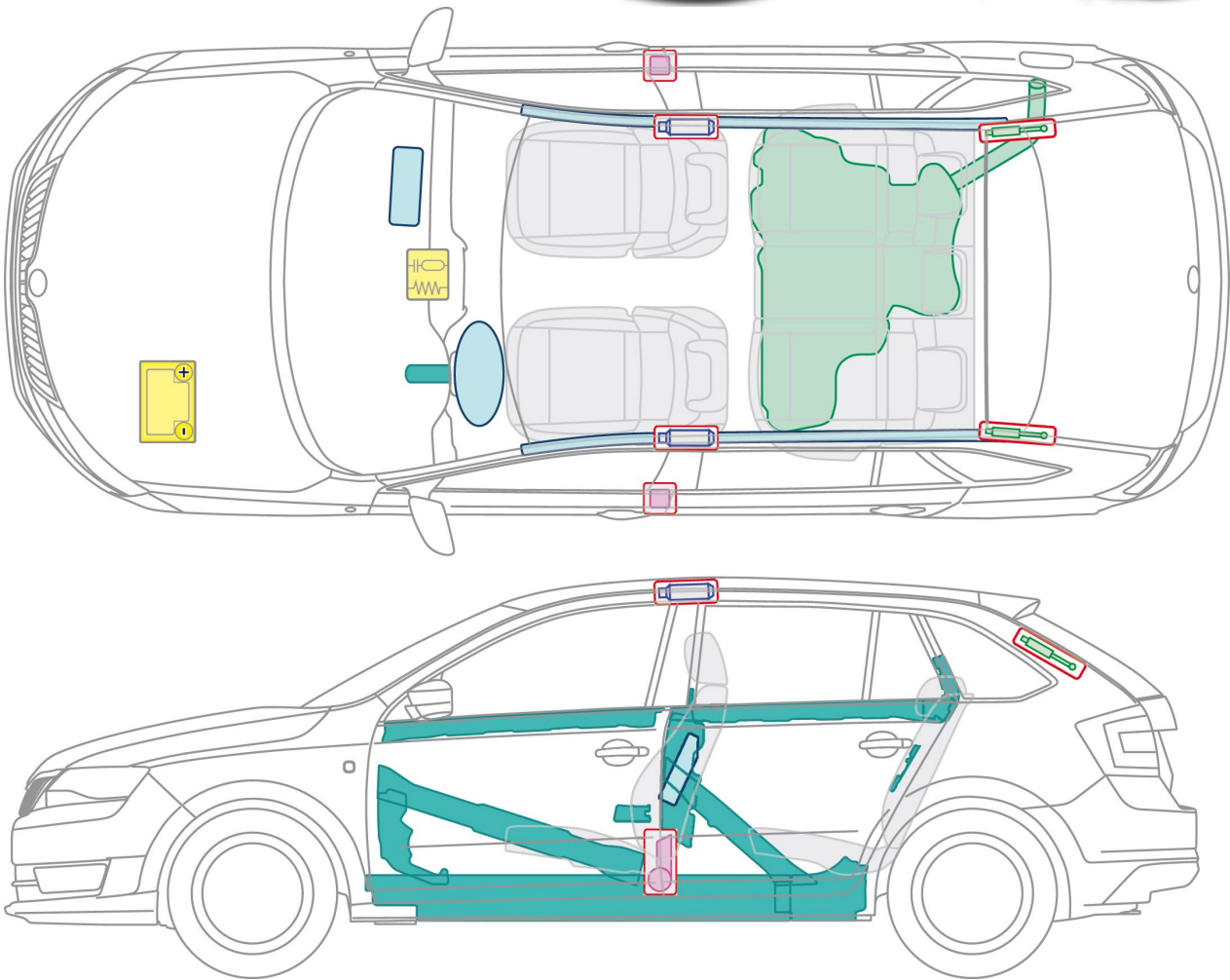

	Airbag		Karosserie- verstärkung		Steuergerät für Airbag
	Gas- generator		Batterie		Gurt- straffer
	Gasdruck- dämpfer		Kraftstoff- tank		



Rapid Spaceback ab 2013

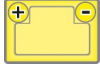
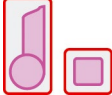

Legende

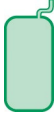



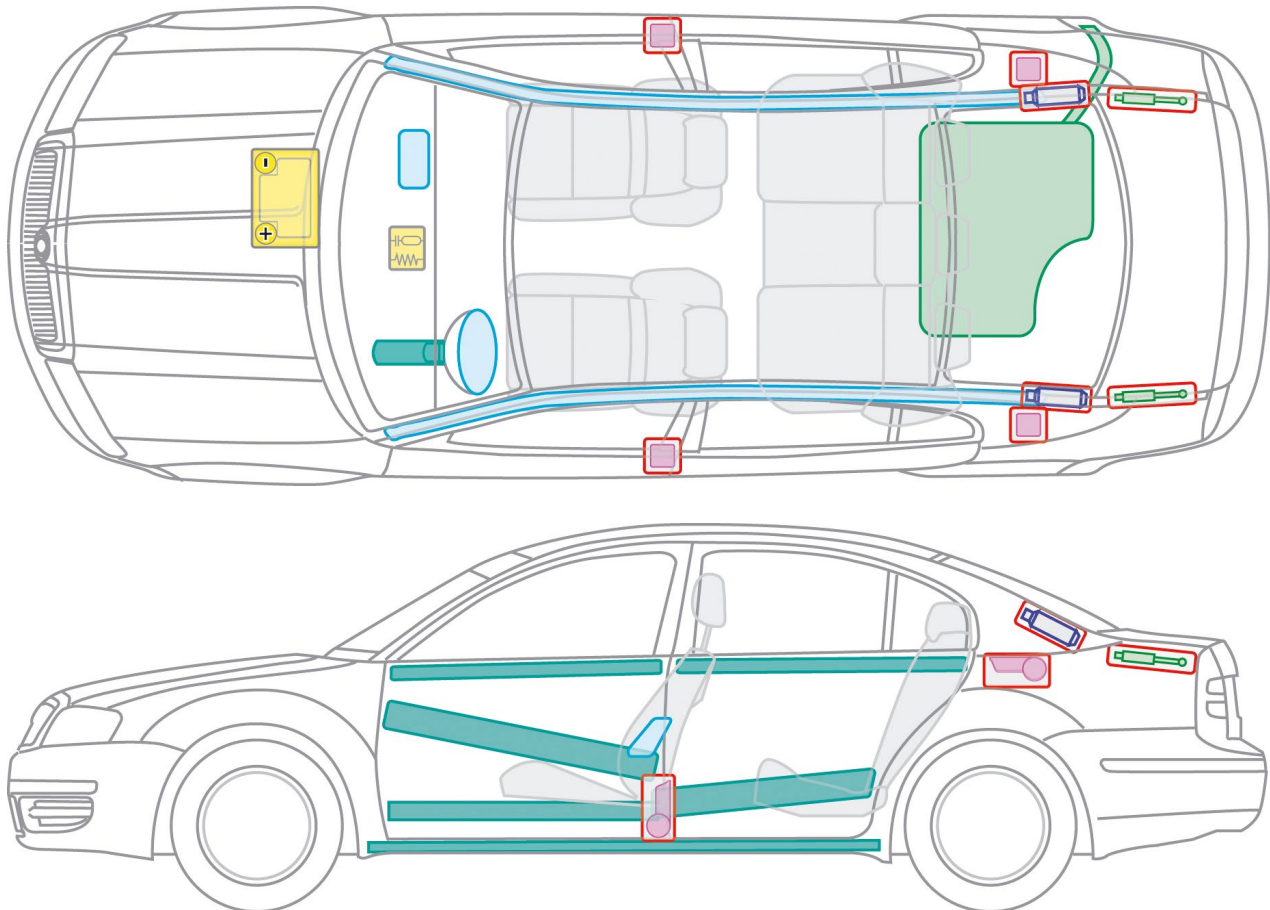

	Airbag		Karosserie- verstärkung		Steuergerät für Airbag
	Gas- generator		Batterie		Gurt- straffer
	Gasdruck- dämpfer		Kraftstoff- tank		

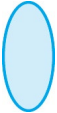

Superb I 2001 - 2008

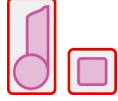

Legende

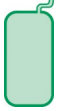
	Airbag		Karosserie- verstärkung		Steuergerät für Airbag
	Gas- generator		Batterie		Gurt- straffer
	Gasdruck- dämpfer		Kraftstoff- tank		





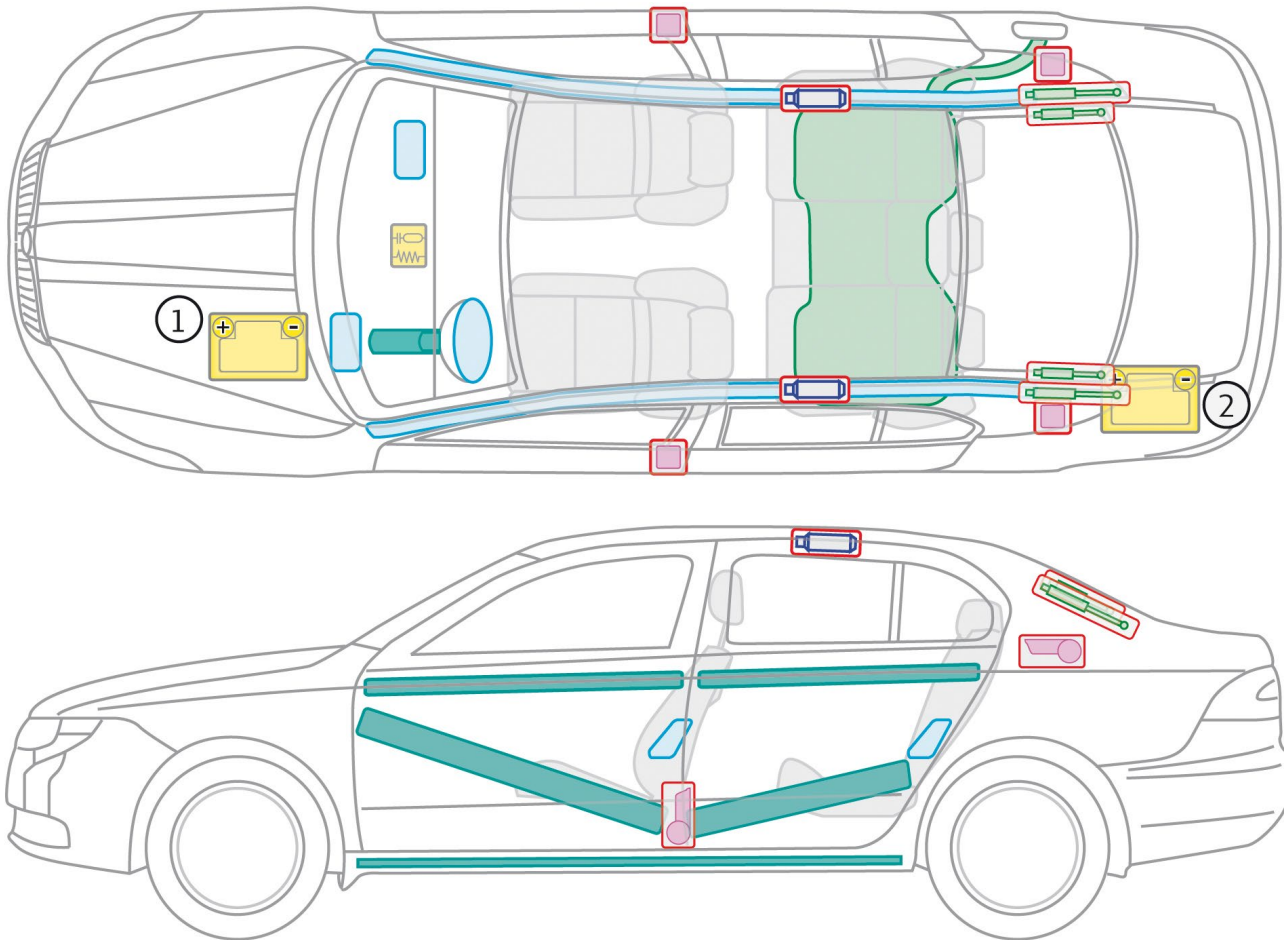



Superb II ab 2008

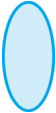

Legende

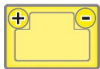
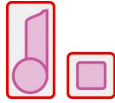
- ① alle Fahrzeuge, außer Motorisierung 3,6 I/191 kW
 ② alle Fahrzeuge, mit Motorisierung 3,6 I/191 kW

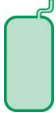
	Airbag		Karosserie- verstärkung		Steuergerät für Airbag
	Gas- generator		Batterie		Gurt- straffer
	Gasdruck- dämpfer		Kraftstoff- tank		





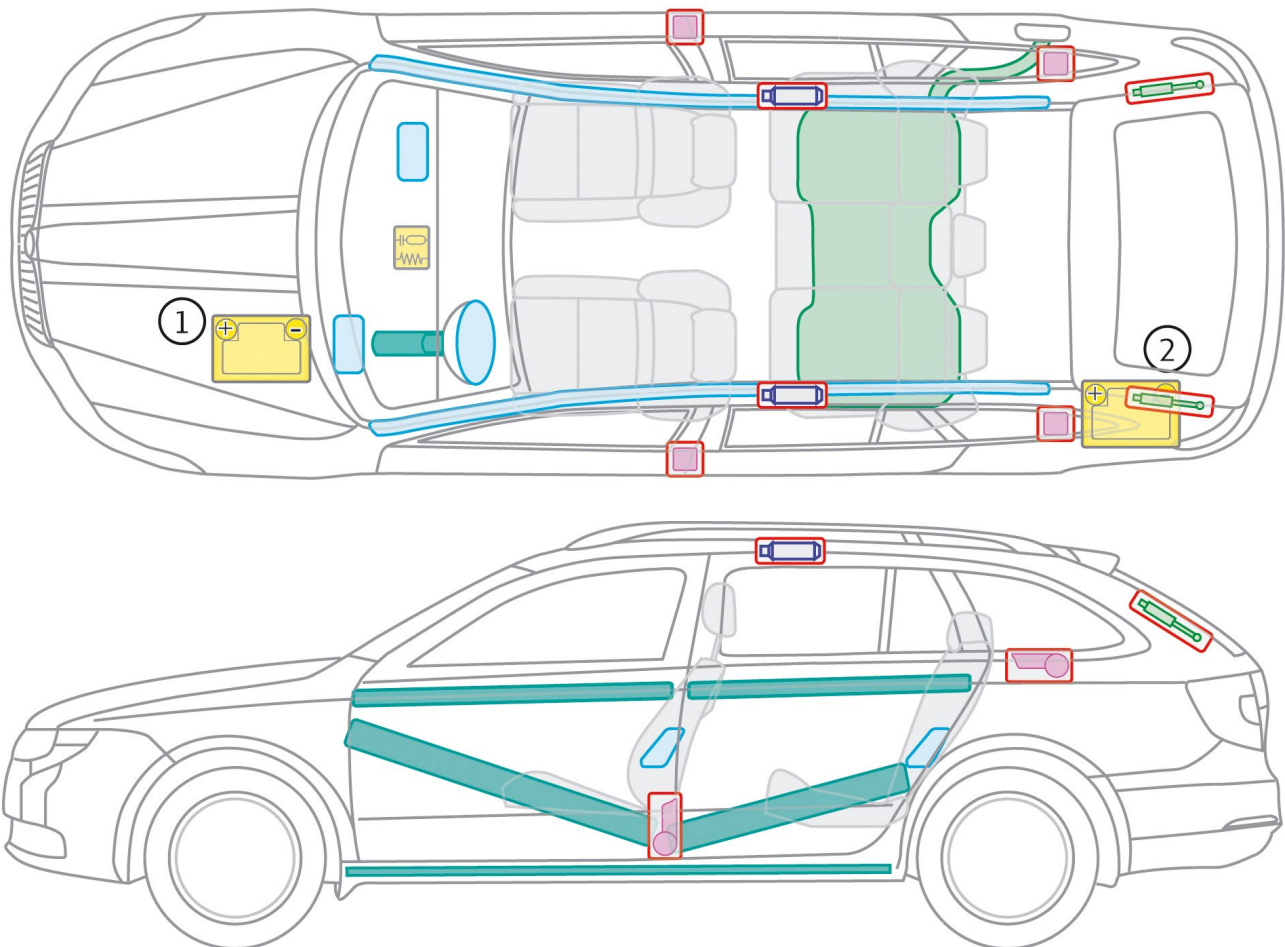



Superb Combi II ab 2009

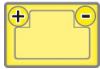
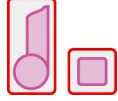

Legende

- ① alle Fahrzeuge, außer Motorisierung 3,6 I/191 kW
 ② alle Fahrzeuge, mit Motorisierung 3,6 I/191 kW

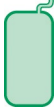



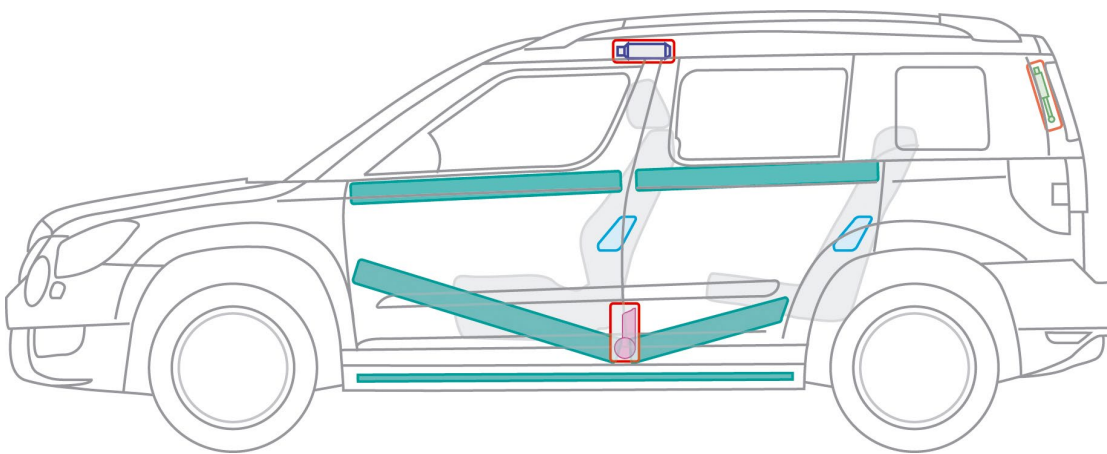
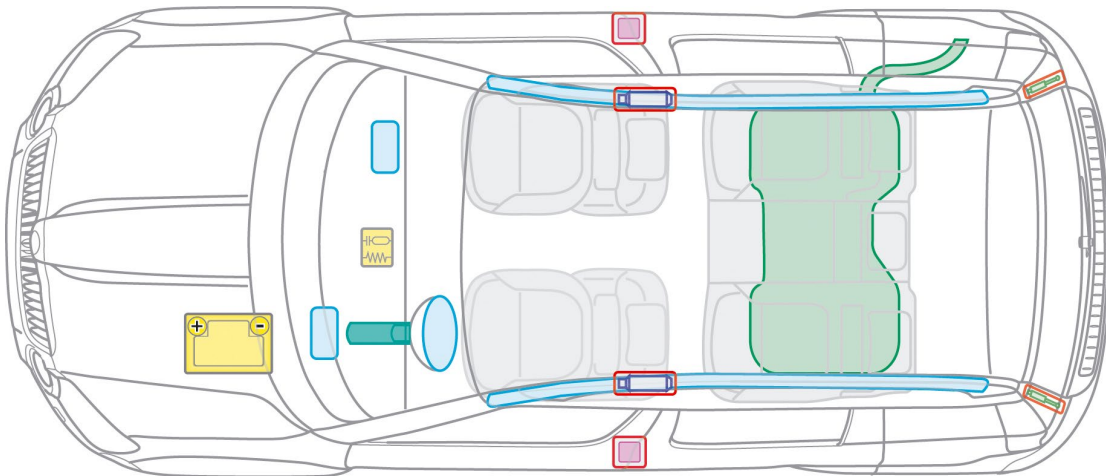

	Airbag		Karosserie- verstärkung		Steuergerät für Airbag
	Gas- generator		Batterie		Gurt- straffer
	Gasdruck- dämpfer		Kraftstoff- tank		

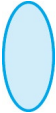

Yeti ab 2009

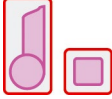

Legende

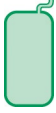
	Airbag		Karosserie- verstärkung		Steuergerät für Airbag
	Gas- generator		Batterie		Gurt- straffer
	Gasdruck- dämpfer		Kraftstoff- tank		